SECTION FIFTEEN

ELECTRICAL SYSTEMS

James M. Bannon
Chief Electrical Engineer
STV Incorporated
Douglassville, Pennsylvania

Design of the electrical installations in a building used to be simple and straightforward. Such installations generally included electrical service from a utility company; power distribution within the building for receptacles, air conditioning, and other electrical loads; lighting; and a few specialty systems, such as fire alarm and telephone. There were, of course, some specialized installations for which this simple description did not apply, but such buildings were uncommon. Now, however, design of electrical systems has become more complex and sophisticated.

This development has been driven by rapid advances in technology, availability of computers and computerized equipment, more enlightened life-safety and security concerns, and changes in the philosophical outlook of workers toward their workplace and their need for a comfortable environment. To meet these needs, a new building will likely include in its electrical installation an access control system, intrusion detection system, an extensive computer data network, Internet access, uninterruptible power supply, and numerous other systems not commonly installed in the past. Corollary to the advent of these new building systems is the need for suitable *power quality* to support them. Though highly sophisticated and capable, these systems can easily be disrupted or damaged by power system anomalies such as sags, surges, noise, and power outages. Electrical design elements to protect against these disturbances must be included and must be designed to be appropriately sensitive, fast, and robust. The introduction of electrical competition in some states adds further complexity to the electrical system design problem.

Not only have these systems become common but the basic electrical systems have undergone drastic changes. Advances in electrical-power-distribution materials and methods, which have occurred at a nearly uniform rate since the turn of the century, have accelerated rapidly under the influence of computers and microprocessor controls. New light sources give designers added opportunities to improve lighting and energy efficiency. Microprocessor-based fire-alarm systems with addressable devices offer greatly improved protection, flexibility, and economy. And establishment of more local telecommunication operating companies and competition between them, encouraging innovation, has brought designers new choices and challenges with respect to telecommunication systems for buildings.

Nevertheless, the basic principles of electrical design still apply, and they are described in this section. In addition, the section was developed to be helpful to those who must assume responsibility for applying, coordinating, integrating, and installing the many electrical systems now available for buildings.

15.1 ELECTRICAL POWER

In many ways, transmission of electricity in buildings is analogous to water-supply distribution. Water flows through pipes, electricity through wires or other conductors. Voltage is equivalent to pressure; wire resistance, to pipe friction; and electric current, or flow of electrons, to water droplets.

The hydraulic analogy is limited to only very elementary applications with electric flow like direct current, which always flows in the same direction. The analogy does not hold for alternating current, which reverses flow many times per second without apparent inertia drag. Direct-current systems are simple two-wire circuits, whereas alternating current uses two, three, or four wires and the formulas are more complex. Any attempt to apply the hydraulic analogy to alternating currents would be more confusing than helpful. The mathematical concepts are the only guides that remain true over the whole area of application.

Ampere (abbreviated A) is the basic unit for measuring flow of current. The unit flowing is an electric charge called a **coulomb**. An ampere is equivalent to a flow of one coulomb per second.

One source of direct current is the battery, which converts chemical energy into electric energy. By convention, direct current flows from the positive terminal to the negative terminal when a conductor is connected between the terminals. The voltage between battery terminals depends on the number of cells in the battery. For a lead-plate-sulfuric-acid battery, this voltage is about 1.5 to 2 V per cell.

For high voltages, a generator is required. A generator is a machine for converting mechanical energy into electrical energy. The basic principle involved is illustrated by the simple experiment of moving a copper wire across the magnetic field between a north pole and south pole of a magnet. In a generator, the rotor is wound with coils of wire and the magnets are placed around the stator in pairs, two, four, six, and eight. When the coil on the rotor passes through the magnetic field under a south pole, current flows in one direction. When the same coil passes through the north-pole field, the current reverses. For this reason, all generators produce alternating current. If direct current is required, the coils are connected to contacts on the rotor, which transfer the current to brushes arranged to pick up the current flowing in one direction only. The contacts and brushes comprise the commutator. If the commutator is omitted, the generator is an alternator, producing alternating current.

See also Conversion of AC to DC in Art. 15.3.

15.2 DIRECT-CURRENT SYSTEMS

Resistance of flow through a wire, measured in units called **ohms** (Ω), depends on the wire material. Metals like copper and aluminum have low resistance and are classified as conductors.

Resistance for a given material varies inversely as the area of the cross section and directly as the length of wire.

Ohm's law states that the voltage E (volts) required to cause a flow of current I (amperes) through a wire with resistance R (ohms) is given by

$$E = IR \quad (15.1)$$

Power P is measured in watts and is the product of volts and amperes:

$$P = EI = (IR)I = I^2R \quad (15.2a)$$

or

$$P = EI = E \left(\frac{E}{R} \right) = \frac{E^2}{R} \quad (15.2b)$$

Large amounts of power are measured in kilowatts (kW), a unit of 1000 W, or megawatts (MW), a unit of 1,000,000 W.

Electric Energy. The energy expended in a circuit equals the product of watts and time, expressed as watt-seconds or watt-hours (Wh). For large amounts of energy, a unit of 1000 watt-hours, or kilowatt-hours, kWh, is used.

Charges for electric use are usually based on two separate items. The first is total energy used per month, kWh, and the second is the peak demand, or maximum kW required over any short period during the month, usually 15 to 30 min.

Power Transmission. Power is usually transmitted at very high voltages to minimize the power loss over long distances. This power loss results from the energy consumed in heating the transmission cables and is equal to the square of the current flowing I , times a constant representing the resistance r of the wires, Ω/ft , times the length L , ft, of the wires. Measured in watts,

$$\text{Heat loss} = I^2rL \quad (15.3)$$

Series Circuits. A series circuit is, by definition, one in which the same current I flows through all parts of the circuit (Fig. 15.1a). In such a circuit, the resistance R of each part is the resistance per foot times the length, ft. Also, by Ohm's law, for each part of the circuit, the voltage drop is

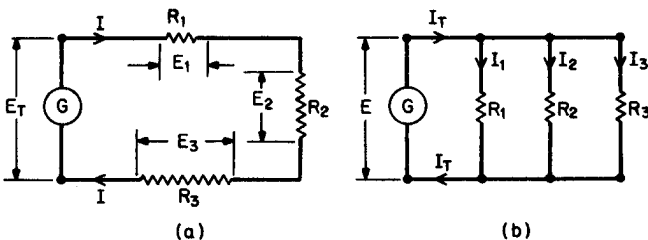

FIGURE 15.1 Types of electric circuits: (a) series; (b) parallel.

$$E_1 = IR_1 \quad E_2 = IR_2 \cdots E_n = IR_n \quad (15.4)$$

Kirchhoff's law for series circuits states that the total voltage drop in a circuit is the sum of the voltage drops:

$$\begin{aligned} E_T &= E_1 + E_2 + E_3 + \cdots + E_n \\ &= IR_1 + IR_2 + IR_3 + \cdots + IR_n \\ &= I(R_1 + R_2 + R_3 + \cdots + R_n) \end{aligned} \quad (15.5)$$

By Ohm's law the total resistance in a series circuit then is

$$R = R_1 + R_2 + R_3 + \cdots + R_n \quad (15.6)$$

Parallel Circuits. These are, by definition, circuits in which the same voltage drop is applied to each circuit (Fig. 15.1*b*). The resistance of each circuit is obtained by multiplying the resistance per foot by the length, ft.

Kirchhoff's law for parallel circuits states that the total current in a circuit is equal to the sum of the currents in each part:

$$\begin{aligned} I_T &= I_1 + I_2 + I_3 + \cdots + I_n \\ &= \frac{E}{R_1} + \frac{E}{R_2} + \frac{E}{R_3} + \cdots + \frac{E}{R_n} \\ &= E \left(\frac{1}{R_1} + \frac{1}{R_2} + \frac{1}{R_3} + \cdots + \frac{1}{R_n} \right) \end{aligned} \quad (15.7)$$

By Ohm's law, then, the total resistance R in a parallel circuit is given by

$$\frac{1}{R} = \frac{1}{R_1} + \frac{1}{R_2} + \frac{1}{R_3} + \cdots + \frac{1}{R_n} \quad (15.8)$$

It is sometimes convenient to use **conductance** G , siemens (formerly mhos), which is the reciprocal of resistance R :

$$G = \frac{1}{R} \quad (15.9)$$

By Ohm's law,

$$I_T = EG_1 + EG_2 + EG_3 + \cdots + EG_n \quad (15.10)$$

Series circuits are most commonly used in street, airport runway, and subway lighting. Most building systems use parallel circuits for both motor and lighting distribution.

Network systems consisting of a combination of series and parallel circuits are used for municipal distribution.

15.3 ALTERNATING-CURRENT SYSTEMS

Any change in flow of current, such as that which occurs in alternating current, produces a magnetic field around the wire. With steady flow, as in direct current, there is no magnetic field.

One common application of magnetic fields is for solenoids. These are coils of wire, with many turns, around a hollow cylinder in which an iron pin moves in the direction of the magnetic field generated by the current in the coil. The movement of the pin is used to open or close electric switches, which start and stop motors, or open and close valves. The pin returns to a normal position, either by gravity or spring action, when the current in the coil is stopped.

The motion of the pin can be predicted by the *right-hand rule*. If the fingers of the right hand are curled around the solenoid with the fingers pointing in the same direction as the current in the coil, the thumb will point in the direction of the magnetic field, or the direction in which the pin will move.

With direct current, a magnetic field exists only as the flow changes from zero to steady flow. Once steady flow is established in the wire, the magnetic field collapses. For this reason, all devices and machines that rely on the interaction of current and magnetic fields must use alternating current, which changes continuously. This equipment includes transformers, motors, and generators.

Transformers. These are devices used to change voltages. A transformer comprises two separate coils, primary and secondary, that wind concentrically around

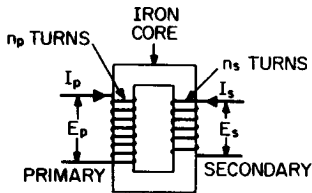

FIGURE 15.2 Transformer.

a common core of iron (Fig. 15.2). A common magnetic field consequently cuts both the primary and secondary windings. When alternating current (ac) flows in the primary coil, the changing magnetic field induces current in the secondary coil. The voltage resulting in each winding is proportional to the number of turns of wire in each coil. For example, a transformer with twice the

number of turns in the secondary coil as in the primary will have a voltage across the secondary coil equal to twice the primary voltage.

AC Generators and Motors. Just as changes in current flowing in a wire produce a magnetic field, movement of a wire through a magnetic field produces current in the wire. This is the principle on which electric motors and generators are built.

In these machines, a rotating shaft carries wire coils wound around an iron core, called an armature. A stationary frame, called the stator, encircling the armature, also carries iron cores around which are wound coils of wire. These cores are arranged in pairs opposite each other around the stator, to serve as poles of magnets. The windings are so arranged that if a north pole is produced in one core a south pole is produced in the opposite core. Current flowing in the stator, or field, coils create a magnetic field across the rotating armature.

There are two basic types of motors and generators, synchronous and induction. In a synchronous machine, the armature has a separate magnetic field produced by a direct current exciter that interacts with the magnetic field of the stator. In an induction machine, the magnetic field in the armature is induced by movement past the stator field.

When the machine is to be used as a motor, voltage is applied across the armature windings, and the reaction with the magnetic field produces rotary motion of the shaft. When the machine is to be used as a generator, mechanical energy is applied to rotate the shaft, and the rotation of the armature windings in the magnetic fields produces current in the armature windings. The current varies in magnitude and reverses direction as the shaft rotates.

Sine-Type Currents and Voltages. In generation of alternating current, rotation of the armature of a generator produces a current that starts from zero as a wire enters the magnetic field of a pole on the stator and increases as the wire moves through the field. When the wire is directly under the magnet, the wire is cutting across the field at right angles and the maximum flow of current results. The wire then moves out of the field and the current decreases to zero. The wire next moves into the magnetic field of the opposite pole, and the process repeats, except that the current now flows in the opposite direction in the wire. This current variation from zero to a maximum in one direction (positive direction), down to zero, then continuing down to a maximum in the opposite direction (negative direction), and back to zero takes the form of a **sine wave**.

The number of complete cycles per second of the wave is called the **frequency** of the current. This is usually 60 Hz (cycles per second) in the United States; 50 Hz in most other European countries.

If P is the number of poles on the stator of a generator, the frequency of the alternating current equals $P \times \text{rpm}/120$, where rpm is the revolutions per minute of the armature. This relationship also holds for ac motors. Hence, for a frequency of 60 Hz, $\text{rpm} = 60 \times 120/P = 7200/P$. This indicates that theoretically a standard four-pole motor would run at 1800 rpm, and a two-pole motor at 3600 rpm. Because of slippage, however, these speeds are usually 1760 and 3400 rpm, respectively.

Phases. Two currents or voltages in a circuit may have the same frequency but may pass through zero at different times. This time relationship is called phase. As explained in the preceding, the variation of the current (or voltage) from zero to maximum is a result of the rotation of a generator coil through 90° to a pole and back to zero in the subsequent 90° . The particular phase of a current is therefore given as angle of rotation from the zero start. If current (or voltage) 1 passes through its zero value just as another current (or voltage) 2 passes through its maximum, current 2 is said to *lead* current 1 by 90° . Conversely, current 1 is said to *lag* current 2 by 90° .

Effective Current and Voltage. The instantaneous value of an alternating current (or voltage) is continuously varying. This current has a heating effect on wire equal to the *effective current* I times the resistance R . Mathematically, the effective current is 0.707 times the maximum instantaneous current of the sine wave. The same relationship holds true for the *effective voltage*.

Ohm's law, $E = IR$, can be used in alternating circuits with E as the **effective voltage**, I , the effective current, A , and R , the resistance, Ω .

Inductive Reactances and Susceptance. When alternating current flows through a coil, a magnetic field surrounds the coil. As the current decreases in instantaneous value from maximum to zero, the magnetic field increases in strength from zero to maximum. As the current increases in the opposite direction, from zero to maximum, the magnetic-field strength decreases to zero. When the current starts to decrease, a new magnetic field is produced that is continuously increasing in strength but has changed direction.

The magnetic field, in changing, induces a voltage and current in the wire, but the phase, or timing, of the zero and maximum values of this induced voltage and current are actually 90° behind the original voltage and current wave in the wire.

The induced voltage and current are proportional to a constant called the **inductive reactance** of the coil. This constant, unlike resistance, which depends on the material and cross-sectional area of the wire, depends on the number of turns in the coil and the material of the core on which the coil is wound. For example, a simple coil wound around an airspace has less inductive reactance than a coil wound around an iron core. Inductive voltage E_L and inductive current I_L , A, are related by

$$E_L = I_L X_L \quad (15.11)$$

where X_L is the constant for inductive reactance of the circuit, expressed in ohms, Ω . The reciprocal $1/X_L$ is called **inductive susceptance**.

When an inductive reactance is wired in a series circuit with a resistance, the inductive reactance does not draw any power (or heating effect) from the circuit. This occurs because the induced current I_L is 90° out of phase with the applied voltage E . In the variation of the instantaneous value of applied voltage, power is taken from the circuit in making the magnetic field. Then, as the magnetic field collapses, the power is returned to the circuit.

Capacitive Reactance and Susceptance. An electrostatic condenser, or capacitor, consists basically of two conductors, for example, flat metal plates, with an insulator between. Another familiar form in laboratory use is the arrangement of two large brass balls with an airspace between. Electrostatic charges accumulate on one plate when voltage is applied. When the voltage is high enough, a spark jumps across the air space. With direct current, the discharge is instantaneous and then stops until the charge builds up again. With alternating current, as one plate is being charged, the other plate is discharging, and the flow of current is continuous. In this case, the circuit is called capacitive.

$$E_C = I_C X_C \quad (15.12)$$

where X_C is the constant for **capacitive reactance**, Ω . The reciprocal $1/X_C$ is called **reactive susceptance**. The current I_C reaches its peak when the impressed voltage E is just passing through zero. Capacitive current is said to lead the voltage by 90° .

Impedance and Admittance. A circuit can have resistance and inductive reactance, or resistance and capacitive reactance, or resistance and both inductive and capacitive reactance. Resistance is present in all circuits. When there is any inductive or capacitive reactance, or both, in a circuit, the relation of the voltage E and current I , A, is given by

$$E = IZ \quad (15.13)$$

where Z is the **impedance**, Ω , the vector sum of the resistance, and the inductive and capacitive reactances. The reciprocal $Y = 1/Z$ is called the **admittance**. Electrical quantities such as E , I , Z , etc., can be represented graphically by **phasors**. These are the same as vectors used in other engineering disciplines and in mathematics but are called phasors because they are used to represent the phase relationship between different electrical quantities.

A **phasor** may be represented by a line and arrowhead. The length of the line is made proportional to the magnitude of E or I , and the arrowhead indicates plus

or minus. In resistance circuits, the phasor E is indicated by a horizontal line with the arrowhead at the right:

$$\overrightarrow{E=IR}$$

In a circuit that contains inductive reactance, the current I_L lags behind the voltage E by 90° . This is indicated by phasors as follows:



The phasor sum of these voltages is indicated by phasors as follows:

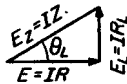

The diagram indicates that

$$E = IZ \cos \theta_L \tag{15.14}$$

where θ_L is the phase angle between voltage and current.

The relation between resistance R and inductance L is indicated by a similar phasor addition:



The diagram indicates that

$$R = Z \cos \theta_L \tag{15.15}$$

In a similar way, capacitive reactance in the circuit is indicated by



and the phasor sum is shown as follows:

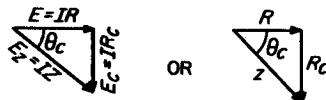

The diagrams indicate that

$$E = IZ \cos \theta_C \quad (15.16)$$

$$R = Z \cos \theta_C \quad (15.17)$$

Note that the phasors for inductance and capacitance are in opposite directions. Thus, when a circuit contains both inductance and capacitance, they can be added algebraically. If they are equal, they cancel each other, and the Z value is the same as R . If the inductance is greater, Z will be in the upper quadrant. A greater value of capacitance will throw Z into the lower quadrant.

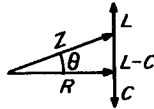

The diagram indicates that

$$\tan \theta = \frac{L - C}{R} \quad (15.18)$$

Kirchhoff's laws are applicable to alternating current circuits containing any combinations of resistance, inductance, and capacitance by means of phasor analysis:

In a **series circuit**, the current I is equal in all parts of the circuit, but the total voltage drop is the phasor sum of the voltage drops in the parts. If the circuit has resistance R , inductance L , and capacitance C , the voltage drops must be added phasorially as described in the preceding. Equations (15.14) to (15.18) hold for ac series circuits. To find the voltage drop in each part of the circuit, compute

$$\begin{aligned} E_R &= IR & E_L &= IX_L & E_C &= IX_C \\ E_Z &= E_R + E_L - E_C & & & & \text{(phasorially)} \end{aligned} \quad (15.19)$$

In a **parallel circuit**, the voltage E across each part is the same and the total current I_Z is the vector sum of the currents in the branches,

$$\frac{E}{R} = I_R \quad \frac{E}{X_L} = I_L \quad \frac{E}{X_C} = I_C$$

For parallel circuits, it is convenient to use the reciprocals of the resistance and reactances, or susceptances, respectively S_R , S_L , and S_C . To find the current in each branch then, compute

$$\begin{aligned} ES_R &= I_R & ES_L &= I_L & ES_C &= I_C \\ I_Z &= I_R + I_L - I_C & & & & \text{(phasorially)} \end{aligned} \quad (15.20)$$

Power in AC Circuits. Pure inductance or capacitance circuits store energy in either electric or magnetic fields and, when the field declines to zero, this energy is restored to the electric circuit.

Power is consumed in an ac circuit only in the resistance part of the circuit and equals E_R , the effective voltage across the resistance, times I_R the effective current.

E_R and I_R are in phase. In a circuit with impedance, however, the total circuit voltage E_Z is out of phase with the current by the phase angle θ . In a series circuit, the current I is in phase with E_R ; the voltage E_Z , on the other hand, is out of phase with E_R by the angle θ . In parallel circuits, the voltage E is in phase with E_R , but the current I_Z is out of phase with E_R . In both circuits, the power P is given by

$$P = E_R I_R \quad (15.21)$$

In series circuits, $E_r = E \cos \theta$ and $P = (E \cos \theta) I_R$. In parallel circuits, $I_R = I \cos \theta$ and $P = EI \cos \theta$. In any circuit with impedance angle θ , therefore, the power is given by

$$P = EI \cos \theta \quad (15.22)$$

Power Factor. The term $\cos \theta$ in Eq. (15.22) is called the power factor of the circuit. Because it is always less than 1, it is usually expressed as a percentage.

Low power factor results in high current, which requires high fuse, switch, and circuit-breaker ratings and larger wiring. Induction motors and certain electric-discharge-lamp ballasts are a common cause of low power factor. Since they are both inductive reactances (coils), the low power factor can be corrected by inserting capacitive reactances in the circuit to balance the inductive effects. This can be done with capacitors that are available commercially in standard kilovolt-ampere, kVA, capacities.

For example, a 120-V, 600-kVA circuit with a 50% power factor has a current of 5000 A. The actual power expended is only 300 kW, but the wire, switches, and circuit breakers must be sized for 5000 A. If a capacitor with a 300-kVA rating is wired into the circuit, the current is reduced to 2500 A, and the wiring, switches, and circuit breakers may be sized accordingly.

Conversion of AC to DC. Alternating current has the advantage of being convertible to high voltages by transformers. High voltages are desired for long-distance transmission. For these reasons, utilities produce and sell alternating current. However, many applications requiring accurate speed control need direct-current motors, for example, building elevators and railroad motors, including subways. In buildings, ac may be converted to dc by use of an ac motor to drive a dc generator, which, in turn, provides the power for a dc motor. The ac motor and dc generator are called a **motor-generator set**.

Another device used to convert ac to dc is a **rectifier**. This device allows current to flow in one direction but cuts off the sine wave in the opposite direction. The current obtained from the motor-generator set described previously is a similar unidirectional current of varying instantaneous value. The only truly nonvarying direct current is obtained from batteries. However, output filters can be added to rectifiers to reduce the amount of voltage variation to nearly zero. In most cases this is acceptable, and using a rectifier as a dc source eliminates the weight, cost, and hazards involved with large storage batteries.

Single-Phase and Multi-Phase Systems. A single-phase ac circuit requires two wires, just like a dc circuit. One wire is the **live wire**, and the other is the **neutral**, so called because it is usually grounded (Fig. 15.3a).

A voltage commonly used in the United States is 240 V, single-phase, two-wire, which is obtained from the two terminals of the secondary coil of transformers fed from utility high-voltage lines. If a third wire is connected to the midpoint of the

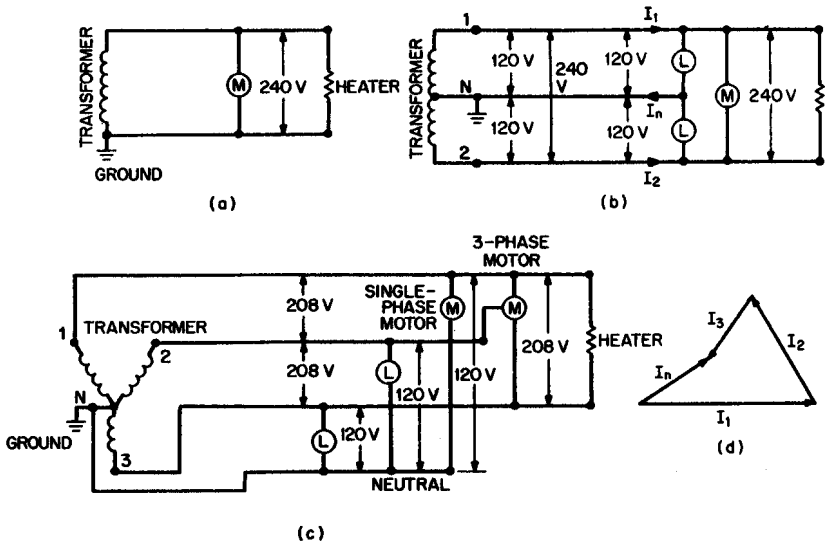

FIGURE 15.3 Examples of circuit wiring: (a) single-phase, two-wire circuit; (b) two-phase, three-wire circuit; (c) three-phase, four-wire circuit; (d) current I_n in the neutral wire of the three-phase circuit is the phasor sum of the currents in the phase legs.

secondary coil as a neutral, the voltage between either of the two terminal wires and the neutral will be 120 V (Fig. 15.3b). This voltage, 120/240 V, single-phase, three-wire, is the voltage used for most residential electrical services.

The currents in the two terminal wires are 180° apart in phase. The neutral current from each is also 180° apart. These two currents, traveling in the same neutral wire, offset each other because of the phase difference. If the load currents in the two terminal wires are equal, the currents in the neutral will become zero. Though there is a phase difference between the two live wires, this is still considered as a single-phase system, designated as single-phase, three-wire.

An outdated voltage system that may be encountered in renovation work is the two-phase system in which the live wires are 90° apart in phase. There are actually two types of two-phase systems, two-phase three-wire and two-phase five-wire.

In a similar way, three-phase electric service can be obtained directly from the utility company with three live wires and a grounded neutral (Fig. 15.3c). The currents in the three live wires, as well as their respective return flows in the neutral, are 120° apart in phase. If the currents are equal in the three live wires, the current in the neutral will be zero.

If the phase currents are not equal, the current in the neutral will be the phasor sum of the phase currents (Fig. 15.3d).

In many two-phase or three-phase systems, it is necessary therefore to balance the single-phase loads on each wire as much as possible. When the current in the neutral is zero, there is no voltage drop in the return circuit. Any voltage drop in the neutral subtracts from the voltage on the single-phase wires and affects the loads on these circuits. The voltage drop times the current flowing in the neutral times the cosine of the phase angle is the power consumed in the neutral wire, and this adds to the total metered power on the utility bill.

15.4 ELECTRICAL LOADS

Electric services in a building may be provided for several different kinds of loads: lighting, motors, communications equipment. These loads may vary in voltage and times of service, as for example, continuous lighting or intermittent elevator motors. Motors have high instantaneous starting currents, which can be four to six times the running current, but which lasts only a brief time.

It is highly improbable that all of the intermittent loads will occur at once. To determine the probable maximum load, **demand factors** and **coincidence factors** (diversity factors) must be applied to the total connected load (see Art. 15.8).

Lighting Loads. The minimum, and often the maximum, watts per square foot of floor area to be used in design are specified by building codes for various uses of the floor area. Maximum wattages are set to conserve energy and should be followed wherever possible. Electrical engineers, however, may exceed the minimum wattages if the proposed use requires more. For example, lighting may be designed to give a high intensity of illumination, which will require more watts per square foot than the code minimum. (Recommended lighting levels are given in the Illuminating Engineering Society "Lighting Handbook.")

Power Loads. In industrial buildings, the process equipment is normally the largest electrical power load. In residential, commercial, and institutional buildings, the power loads are mainly air-conditioning equipment and elevators. Some commercial and institutional buildings, though, contain significant computer and communication equipment loads, and special attention is required to properly serve these electronic equipment loads.

Electronic Equipment Loads. The electric power from the utility company is contaminated with electrical noise and spikes and is subject to sags, surges, and other power-line disturbances. The sensitivity of electronic equipment requires that the electrical system include equipment that will reduce the effect of these disturbances. Selection of this protection equipment should be based on the functions to be performed by the electronic equipment and a consideration of the consequences disturbance might cause, such as disruption of service lost data equipment damage and attendant costs. Most manufacturers specify the power quality needed for satisfactory operation of their electronic equipment. In fact, manufacturers of many computer systems furnish specific site-preparation instructions that address not only electrical power, but also lighting, air conditioning, grounding, and room finishes.

For protection purposes, for a personal computer or workstation, it may be only necessary to provide a good-quality plug-in strip with a transient-voltage surge suppressor (TVSS). A medical imaging system, such as a CAT-scan machine, may require a "power conditioner" that combines a voltage regulator, to eliminate sags and surges, with a shielded isolation transformer, to block spikes and noise. In critical installations, though, where equipment failure or an outage can have serious effects, more extensive steps must be taken. For example, loss of service to a satellite communication facility, a banking computer center, or an air-traffic control tower can have severe adverse consequences. To prevent this, such facilities should be provided with an uninterruptible power supply, backed up by either an alternate utility service or a stand-by generator.

A commonly used **uninterruptible power supply** (UPS) has a rectifier that is fed from the utility power line and delivers dc power to a large bank of batteries,

keeping them fully charged, and to an inverter, which converts the dc back into high-quality ac power (Fig. 15.4). This arrangement isolates the electronic equipment from the utility power line, and, if the utility power fails, the batteries will instantly deliver power to the inverter, which will serve the load for 15 to 30 min. The stand-by generators will start and assume the load until the utility power is restored. To allow for the possibility that the generator may not start, the batteries should be designed to provide a “protection time” long enough to allow an orderly shutdown of the equipment. The UPS includes a fast-acting, internal, static bypass switch, used in case the UPS itself fails.

Most electronic equipment will draw large amounts of harmonic current, principally odd-number harmonics (180 Hz, 300 Hz, . . .), which can overload and damage electrical equipment. Also, triplen harmonics (3rd, 6th, . . .) add arithmetically and can overload a neutral conductor without tripping a breaker or blowing a fuse. To compensate for this, system neutral capacities must be increased. Empirical data indicate that, in systems with heavy electronic equipment loads, the neutral current will be about 1.8 times the phase current. So, use of a double-capacity neutral will usually suffice. Other system components, such as transformers (k-rated) and circuit breakers, also must be selected to operate satisfactorily for high harmonic loads.

Grounding. The National Electrical Code (NEC) requires an equipment ground system for every electrical installation to ensure personal safety. In sensitive electronic installations, a facility grounding system has the additional requirement of preventing damage to extremely sensitive computer equipment. Soil-resistivity measurements should be obtained at the site for use in design of a low-impedance ground system that will safely conduct lightning discharge currents to earth and allow sufficient ground current to flow to enable circuit-protective equipment to trip under fault conditions.

In addition, a low impedance (0.1 ohm or less) signal-reference ground system (often referred to as an equipotential plane) should be connected to the building ground. All electronic equipment and peripherals, as well as electrical equipment, HVAC equipment and ductwork, piping, raised floor system, and structural steel in proximity with the computer equipment should be connected to this system to ensure that all these items are at the same ground potential. This will ensure that ground current will not flow through the equipment and will also lessen potential damage from electrostatic discharge (ESD). For this purpose, a manufactured cop-

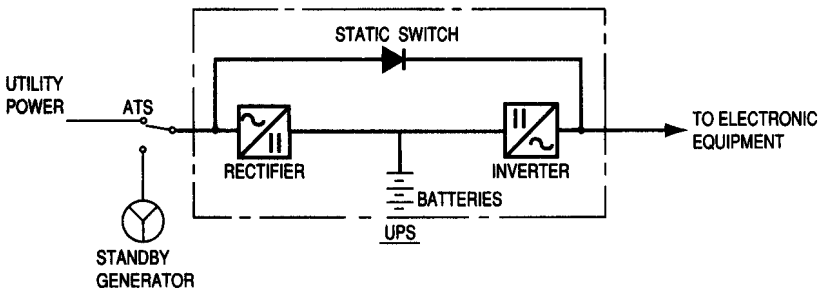

FIGURE 15.4 Typical uninterruptible power supply (UPS) with standby generator serving electronic equipment loads.

per grid with 2-ft by 2-ft spacing may be used. It should be located under the entire raised floor area.

15.5 EMERGENCY POWER

Local and national codes will dictate which electrical systems are required to be served by an emergency power system. NFPA 101, "Life Safety Code," and NFPA 99, "Health Care Facilities," and NFPA 110, "Emergency and Standby Power Systems," published by the National Fire Protection Association, contain specific definitions of required emergency power loads but, in general, they include the following:

Emergency systems, including emergency and egress (exit) lighting, essential ventilation systems, fire detection and alarm systems, elevators, fire pumps, public safety communications systems, and industrial processes where interruption could cause life safety risk. Power must be restored to these loads in not less than 10 s (or less, depending on local codes).

Legally-required standby systems, including heating and refrigeration systems, communications systems, ventilation and smoke removal systems, sewage disposal, lighting systems, and industrial processes, where interruption could create hazards or hamper rescue or fire-fighting operations. Power must be restored to these loads in not less than 60 s (or less, depending on local codes).

Optional standby systems, including heating and refrigeration systems, data processing and communications systems, and industrial processes, where interruption could cause discomfort, serious interruption of the process, damage to the product or process, or the like. Power restoration to these loads should occur, as determined by the engineer, in a period that will adequately protect the loads or process.

Small facilities may only need emergency power for emergency and egress lighting, in which case, fixtures with self-contained battery backup may be adequate. Larger facilities generally require an engine generator to provide emergency power. Emergency loads are connected to a dedicated panelboard or switchboard fed through an automatic transfer switch (ATS) that will detect loss of utility power, signal the generator to start, and transfer the emergency loads onto the generator, all in 10 s or less. After utility power returns, the ATS will retransfer the emergency loads back to utility power and then stop the generator. To prevent equipment damage and voltage surges, an ATS should be provided with an in-phase monitor that waits until the generator drifts into synchronism with the utility source before allowing retransfer.

Generator fuel source may be gasoline, LP gas, diesel fuel, or (if acceptable to the authority having jurisdiction) public utility gas. Local and federal environmental regulations should be consulted if it will be necessary to store liquid fuels. If an aboveground storage tank will be needed, it must be a double-walled tank equipped with electronic leak detection. A subbase, fuel-storage tank, that is an integral part of the generator frame, may also be used for liquid fuel.

Though normally used only for emergency power, the generator, if large enough, may be used to reduce electric bills through demand peak shaving or as a cogen-

erator. Opportunities for these possibilities should be reviewed with the utility company.

Where acceptable to the authority having jurisdiction, a second utility service may be used to provide emergency power. This approach should be evaluated carefully to ensure that the separate service is designed to minimize the possibility of simultaneous interruption of both services.

15.6 ELECTRICAL CONDUCTORS AND RACEWAYS

All metals conduct electricity but have different resistances. Some metals, like gold or silver, have very low resistance, but they do not have the tensile strength required for electrical wire and are too costly. Consequently, only two metals are used extensively in buildings as conductors, copper and aluminum. The choice of copper or aluminum will be based on installed cost, and since aluminum conductors are less costly than copper conductors, one would expect that aluminum conductors would always be chosen. However, several factors should be considered: To carry a given amount of current, a larger aluminum wire is needed, and its raceway may also need to be larger. Because aluminum conductors expand more than copper as they warm up under load, they tend to move back and forth at terminals and, unless the proper termination methods and wiring devices (marked CO/ALR) are used, the conductors may work loose and create a fire hazard. Also, some local building codes and agency standards either do not permit aluminum conductors to be used, or restrict their use to larger wire sizes.

Conductors may be solid round wire, stranded wire, or bus bars of rectangular cross section. Usually, conductors are wrapped in insulation of a type that prevents electric shock to persons in contact with it. The type of insulation also depends on the immediate environment surrounding the wire in its proposed use; dry or moist air, wetness, buried in earth, temperature, and exposure to mechanical or rodent damage.

Each size of commercial wire with a particular insulation is given by building codes a safe current-carrying capacity in amperes, called the **ampacity** of that wire. The code ampacity is based on the maximum heating effect that would be permitted before damage to the insulation.

The codes also require that wires installed in a building be protected from mechanical damage by encasement in pipes, called conduits, or other metal and non-metallic enclosures, termed raceways.

15.6.1 Safety Regulations

The safety regulations for use of wire in buildings are given in local building codes, which are usually based on the National Fire Protection Association "National Electric Code" (see Art. 15.8). These codes are revised frequently, so the engineer should determine which edition should be followed. There is the temptation to simply use the edition most recently published, but since these codes are adopted by the local authorities, the engineer should check with the authority having jurisdiction to determine the latest edition that has been adopted.

Another agency, Underwriters Laboratories, Inc., tests electric materials, devices, and equipment. If approved, the item carries a UL label of approval.

15.6.2 Major Distribution Conductors

Most buildings receive their electrical power supply through service conductors from the street mains and transformers of a public utility.

The **service conductors** may be underground or above ground if taken from a utility-system pole. If a building is set back a great distance from the street poles, additional poles can be installed on the customer's property or the service conductors may be placed in an underground conduit extending to the building from the street pole. The engineer must design electrical services to comply with the requirements of the local electric utility.

At the building end, the service conductors come into a steel entrance box mounted on the building wall and then are brought to a service switch or circuit breaker. Service switches are commercially available up to 6000 A. Where the service load is greater, two or more service switches can be installed, up to a limit of six main service switches, called *drops*, on each service.

For large buildings, where six drops are not sufficient, the utility will install additional services with six drops available on each service. The utility may also provide medium-voltage service to larger buildings. In this case, the building owner must provide and maintain the building service transformer in addition to the other equipment described above.

Each service switch feeds a distribution center or groups of distribution centers, called panelboards. The connection between switch and panelboard is called a **feeder**. These main distribution panelboards consist of several circuit breakers or fused switches. Each of these breakers or switches feeds a load, either a motor or another remote panelboard or group of panelboards. The panelboards, in turn, serve branch circuits connected to lighting, wall receptacles, or other electrical devices.

Distribution systems in buildings are usually three-phase, four-wire. The final branch circuits are generally single-phase, two-wire. One wire in each circuit is grounded. The grounded circuit conductor in a feeder is colored white or natural gray, in accordance with the color code of the "National Electrical Code." The three, phase conductors must also be color coded. This is necessary to ensure that phases are not crossed, to allow balancing of the loads on each phase, and to ensure proper rotation of motors. Colored insulation materials may be used for wires up to No. 6 size. For larger size wires, the phase wires may be identified by applying colored markings at the connections using colored tape.

In a **branch circuit**, the equipment grounding conductor is colored green. When several grounded conductors are in one feeder raceway, one of the grounded conductors should be colored white or gray. The other grounded conductors should have a colored stripe (but not green) over the white or gray, and a different color should be used for the stripe on each wire. For four-wire systems, the colors for ungrounded conductors are usually blue, black, and red, with white used for the grounded conductor.

Conductor ampacity depends on the accumulative heating effect of the IR power loss in the wire. This loss is different for a given size wire with different insulations and depends on whether the wire is in open air and can dissipate heat or confined in a closed conduit with other heat-producing wires. Tables in the "National Electrical Code" give the safe ampacity for each type of insulation and the derated ampacity for more than three current-carrying wires in a raceway.

15.6.3 Types of Insulated Conductors

Following is a list of the various types of insulated conductors rated in the National Electrical Code:

Type MI. Mineral-insulated cable sheathed in a watertight and gastight metallic tube. Cable is completely incombustible and can be used in many hazardous locations and underground. MI cable can also be fire-rated, making it acceptable as a fire-pump feeder.

Type MC. One or more insulated conductors, sheathed in an interlocking metal tape or a close-fitting, impervious tube. With lead sheath or other impervious jacket, Type MC may be used in wet locations.

Type AC. (Also known as BX cable.) This has an armor of flexible metal tape with an internal copper bonding strip in close contact with the outside tape for its entire length. This provides a grounding means at outlet boxes, fixtures, or other equipment. Type AC cable may be used only in dry locations.

Type ACL. In addition to insulation and covering as for Type AC, Type ACL has lead-covered conductors. This makes this type suitable for wet or buried locations.

Type ACT. Only the individual conductors have a moisture-resistant fibrous covering.

Type NM or NMC. Nonmetallic-sheathed cables (also known as Romex). This type may be used in partly protected areas. The New York City Code permits BX (Type AC) but does not allow Romex because it is not rodentproof and is subject to nail damage in partitions.

Type SE or USE. Service-entrance cable has a moisture-resistant, fire-resistant insulation with a braid over the armor for protection against atmospheric corrosion. Type USE is the same as Type SE, except that USE has a lead covering for underground uses.

Type UF. This type is factory assembled in a sheath resistant to flames, moisture, fungus, and corrosion, suitable for direct burial in the earth. The assembly may include an uninsulated grounding conductor. Cables may be buried under 18 in of earth or 12 in of earth and a 2-in concrete slab.

15.6.4 Nonmetallic Extensions

Two insulated conductors within a nonmetallic jacket or extruded thermoplastic cover may be used for surface extensions on walls or ceilings or as overhead cable with a supporting steel cable made part of the assembly. Extensions may be used in dry locations within residences or offices.

Aerial cables may be used only for industrial purposes. At least 10 ft should be provided above the floor as clearance for pedestrians only, 14 ft for vehicular traffic.

15.6.5 Cable Bus and Busways

Busways are bar conductors of rectangular cross section, which are assembled in a sheet-metal trough. The conductors are insulated from the enclosure and each other.

Busways must be exposed for heat dissipation. They are arranged with access openings for plug-in and trolley connections.

For heavy current loads, such as services, several insulated cables may be mounted in parallel, at least one diameter apart, within a ventilated metal enclosure with access facilities. Cable bus costs less than bus bars for the same load but generally takes up more space. Use is limited to dry locations.

15.6.6 Electrical Connections

A variety of devices are commercially available for connecting two or more wires. One type, a pressure connector, called a wire nut, may be screwed over two or three wires twisted together. Another type consists of end lugs attached to wires by squeezing them together under great pressure with a special tool. The lugs have a flat extension with a bolt hole for connection by bolts to a switch or busway. As an alternative, two wires may be joined together in a similar manner with a barrel-shaped splice.

All metal connectors should be insulated with either tape or manufactured insulated covers and should be enclosed in a metal box with cover. Several connections properly insulated can be enclosed in the same metal box if the box is adequate in size. The number of spliced conductors in a box is limited by building codes.

15.6.7 Raceways

A raceway is a general term used to describe the supports or enclosures of wires. For most power distribution systems in buildings, rigid conduit or tubing is used. The dimensions of such conduit or tubing and the number of wires of each size permitted is fixed by tables in the "National Electrical Code." Three or more conductors may not occupy more than 40% of the interior area, with some exceptions for lead-sheathed cable. All metallic raceways must be continuously grounded.

One wide use of **rigid steel conduit**, galvanized, is for branch circuits buried in the concrete slabs of multistory buildings.

Electrical metallic tubing is a thin-walled tube that is permitted by codes in locations where the raceway is not subject to physical damage.

For economy in industrial installations, a continuous, rigid structure may be designed to carry both power and signal wiring. This structure may be in the form of a trough, a ladder run, or a channel. It is limited in use to certain cables specifically approved by Underwriters Laboratories for such use.

Flexible metallic conduit, also known as Greenfield, is a continuous winding of interlocking metal stripping similar to that used for Type AC metal-clad cables (BX). These conduits are often used in short lengths at the terminal connection of a feeder to a motor. For wet locations, a watertight-type (Sealtite) is available.

Surface raceways are usually oval shaped and flat. When painted the same color as the wall or ceiling, they are less conspicuous than round pipe conduit. Surface raceways with a larger, rectangular cross section may be used to mount receptacles or telephone or data outlets, in addition to housing wiring.

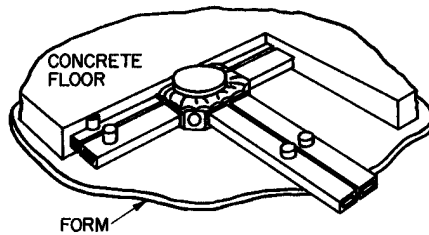

FIGURE 15.5 Raceways incorporated in a concrete floor, with outlet cover at the top of the floor.

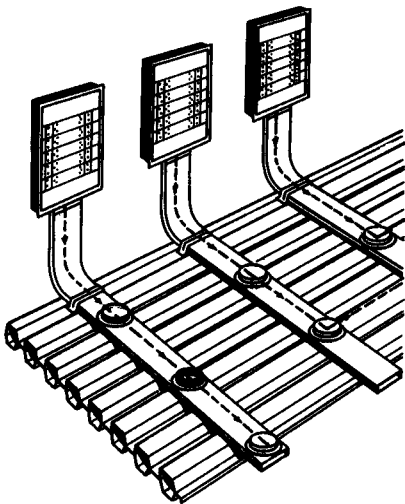

FIGURE 15.6 Cellular steel decking serves as underfloor electric ducts. Wires in headers distribute power to wires in the cells.

Underfloor raceways are ducts placed under a new floor in office spaces where desks and other equipment are frequently moved. Laid in parallel runs 6 to 8 ft apart, with separate ducts for power, signal, and telephone wires, these raceways may have flat-plate outlet covers spaced 4 to 6 ft along each run. Large retail stores also find these installations a great convenience. The alternative is feeder runs above the hung ceiling of the story below, with fire-rated, *poke-through* construction to reach new outlets above the floor.

Underfloor raceways may be single-level (Fig. 15.5) or two-level (Fig. 15.6). In steel-frame buildings, with cellular steel decking, single-level raceways may be included in the structure of the floor itself. A concrete header across the cellular runs provides the means of entering from the finished floor. A similar arrangement can be used in cellular precast-concrete decks, with metal headers for connections. Wireways to carry large numbers of conductors carrying light-current signal or control circuits are commercially available in fixed lengths.

15.6.8 Access Floor Systems

In large computer rooms and in offices with heavy computer or communications usage, such as a brokerage or a data center, an access floor system may be used. This offers a false floor above the structural floor. The system consists of 2-ft by 2-ft removable panels, topped with a floor covering, which are supported from 6 to 36 in, or more, above the structural floor by pedestals and stringers. The space below the access floor is used for routing electrical, computer, and communication wiring. It is also used as a plenum for distributing conditioned air to the equipment and the occupied space. Since virtually the entire underfloor space is available and

accessible, this system, though relatively expensive, offers flexibility for making changes in space use, such as adding equipment or rearranging room layouts.

15.6.9 System Furniture

Most modern offices undergo frequent relocation of staff due to workload, project teaming, or organizational changes. This high “churn rate” is made less of a burden to building managers by the use of *system furniture*. **System furniture** is a coordinated system of components including partitions, work surfaces, and storage elements that can be assembled into a variety of workstation configurations. Although, design of system furniture is not an electrical item of work, the task lighting, power, and voice/data elements are integral to the system. Individually controlled task lighting is provided for each workstation, as are power and voice/data outlets. To accommodate the required services, the specifications must include clear definition of the types and configuration of the electrical components. Furniture specifications will include wiring harness, power, lighting, and voice/data distribution as integral parts of the system. Particular attention should be paid to the method for feeding the system furniture from building services, capacity and bending restrictions of voice/data raceways (network cables) (see Fig. 15.7), and increased neutral currents caused by harmonic loads. Often, a wiring harness will have eight conductors; three phases, three neutrals (one per phase), an equipment ground conductor, and an isolated ground conductor.

15.6.10 Flat Conductor Cables (FCC)

These offer similar flexibility to that of an access floor system in that such cables permit outlets to be located anywhere in a room and allow easy relocation of an outlet. Flat conductor cables are available not only as power circuits but also in multiconductor, twisted pair, coaxial, and fiber-optic cables for use in communication and data systems. Manufacturers offer complete lines of power, data, and communication floor fittings for FCC system use. Use of FCC is limited to installation under carpet squares and is most commonly used in renovation work.

15.7 POWER SYSTEM APPARATUS

Most buildings, commercial, industrial, institutional, and residential, receive their power from a public utility. Usually, the customer is given a choice of voltages. For example, 240/120-V single-phase, three-wire service is, very common in suburban and rural areas. This service comes from a single-phase, 240-V transformer, with one wire from each end of the secondary coil and with the neutral from the midpoint of its secondary coil. The voltage between the end terminal connections is 240 V and between each end wire and the neutral, 120 V (Fig. 15.3b).

In large cities, the service to large buildings can be 208/120 V, three-phase, four-wire, with 208 V available between phase wires and 120 V between a phase wire and the neutral (Fig. 15.3c). Another choice is 480/277 V, three-phase, four-wire, with 277 V available between a phase leg and the neutral. It is more economical to use the higher voltage, 480/277 V, for motors and industrial lighting.

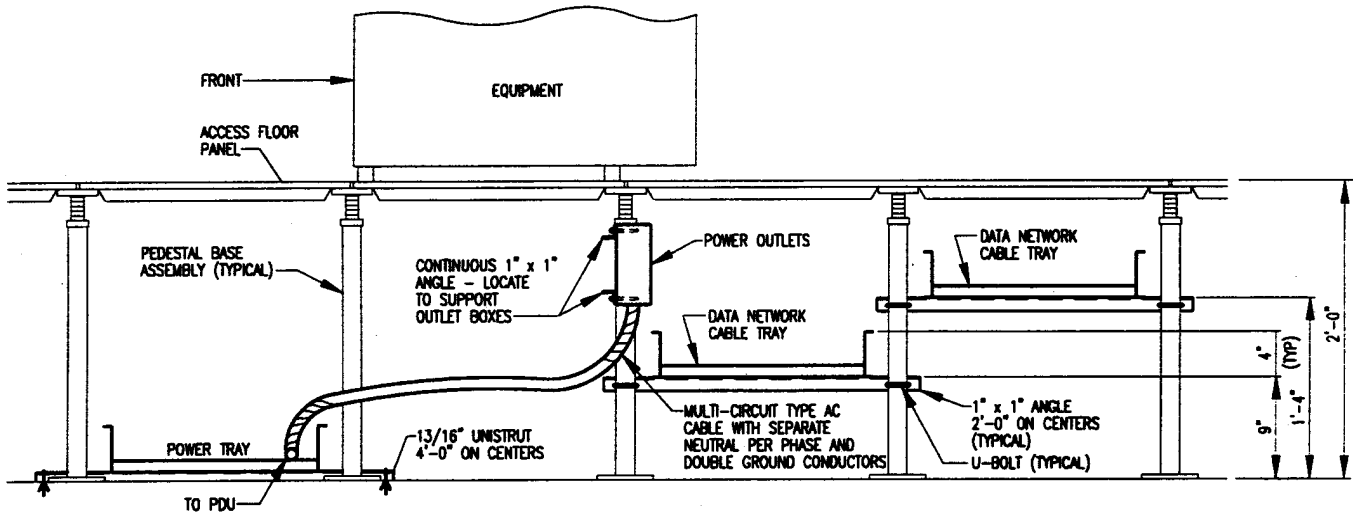

FIGURE 15.7 Space beneath a raised access floor can be used for routing power and voice/data network cables to equipment. Care must be taken to use cables listed for use in air-handling spaces of buildings.

The lower voltage 208/120 V is required for residential or commercial lighting and appliances.

In some areas, the utility will provide both voltage services on separate meters to a large building. But in other areas, the customer must choose one or the other voltage from only one meter and then use transformers to provide the second voltage service.

15.7.1 Transformers

Transformers may be dry or liquid-immersed type. The liquid-immersed type is used for large installations. If the liquid is mineral oil, special fire-protection precautions are needed. Any liquid-filled transformer requires means for containing the liquid if the transformer tank should leak.

All transformers are rated in kVA, with primary and secondary voltages. Taps may be provided on the primary to compensate for variations in utility voltage as much as 10% below and 5% above nominal voltage, in 2½% increments. The manufacturer can also make available to the engineer the reactance and resistance of the coils and the noise rating. Noise can be minimized by use of vibration isolation mountings.

The power losses in a transformer create heat, which must be dissipated. Dry-type transformers are cooled by circulating air in the spaces enclosing the transformers. For liquid-filled transformers, which usually have very high capacity, the liquid may be circulated through coolers to transfer heat from the coils. Average losses in transformers used in buildings are about 2% of the rated capacity.

15.7.2 Meters

Consumption of electrical energy is measured by watt-hour meters. Utilities also include another charge, for demand, based on the maximum amount of power used in a specified time interval, usually about 15 to 30 mm.

Three-wire meters are generally used for residences, either 208 V or, in some areas, 230/240 V. The 208-V service is usually taken from a three-phase, four-wire street or pole main. The voltage therefore differs 120° in phase from the current. There is a 120-V difference between the third, or neutral, wire and the phase leg. For the three 120-V, single-phase circuits, the total power, W , is computed from

$$P = 3EI \cos \theta \quad (15.23)$$

where E = voltage between phase legs and neutral

I = current, A

$\cos \theta$ = power factor

Industries and commercial installations with large motors require three-phase, four-wire meters. Distribution can be over one of three different types of circuits: 208 V, three-phase (motors); 208 V, single-phase (motors, appliances); or 120-V, single-phase (lighting, motors, appliances).

Meters for services supplied by a utility are provided and installed by the utility. The meter pans and current transformers must be provided by the customer in accordance with the utility's requirements.

All the service to one building may be measured by one meter, usually called a master meter. Buildings with rented spaces may have one meter for the owner's load and individual meters for each tenant.

15.7.3 Switches

These are disconnecting devices that interrupt electric current. Toggle switches (Fig. 15.8a) or snap switches are used for small currents like lighting circuits. They employ pressure contacts of copper to copper. Knife switches (Fig. 15.8b) are used for larger loads. A single-phase knife switch employs a movable copper blade hinged to one load terminal. To close a circuit, the blade is inserted between two fixed copper blades connected to the other terminal. The ground leg is usually continuous and unswitched, for safety reasons. For multiphase circuits, one hinged blade is used for each phase; thus, the switch may be double-pole (Fig. 15.9a) or three-pole (Fig. 15.9b), as the case may be.

A switch may be single-throw (Fig. 15.8b), as described, or double-throw (Fig. 15.9c). A double-throw switch permits the choice of connecting the load (always on the movable blade) to two different sources of power, each connected to opposite, fixed blades.

Once the blades of a switch are in solid contact, the heating effect at the contact surface is minimized. Opening and closing the switch, though, draws a hot arc, which burns the copper. This may cause an uneven surface of contact, with continuing small arcs across the separated points, and result in continual weakening of the contact switch and eventual breakdown.

Switches are carefully rated for load and classified for use by the National Electric Manufacturer's Association (NEMA) and the Underwriters Laboratories (UL). For example, a motor-circuit switch, which carries a heavy starting current, is rated in maximum horsepower allowed for connection.

Many types of service-entrance switches are available to meet the requirements of utility companies. They may be classified as fuse pull switch, externally operated safety switch, bolted pressure contact-type switch, or circuit breaker. In any case, the service switch must have a UL service-entrance label affixed.

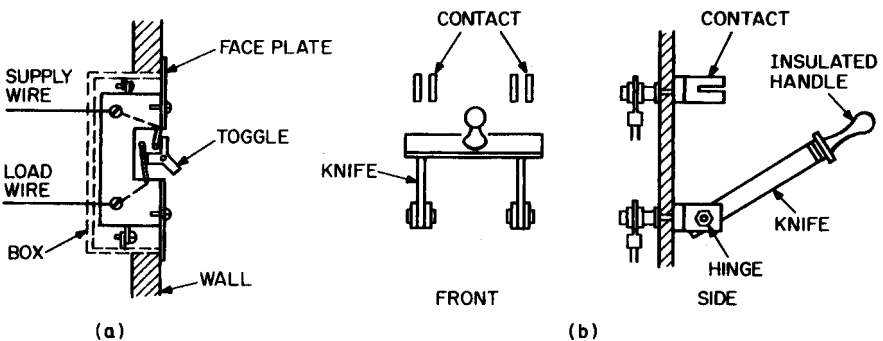

FIGURE 15.8 Switches: (a) snap; (b) blade. (Reprinted with permission from F. S. Merritt and J. Ambrose, "Building Engineering and Systems Design," Van Nostrand Reinhold Company, New York.)

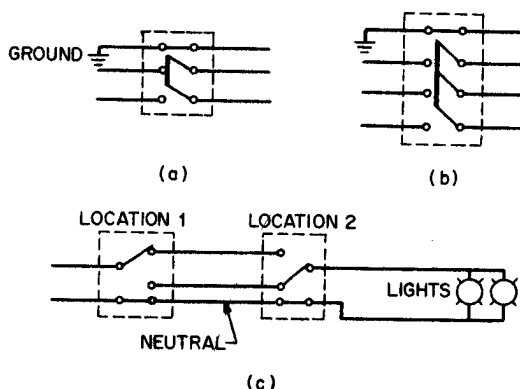

FIGURE 15.9 Single- and double-throw switches: (a) Double-pole, single-throw switch; (b) triple-pole, single-throw switch; (c) single-pole, double-throw switches used for remote control of lights from two locations.

An isolating switch may not be used to interrupt current. It should be opened only after the circuit has been interrupted by another general-use switch. Since isolating switches are very light, an arc will create high temperatures and can severely burn the operator.

For control of large, separate loads, the live copper blades of the various switches are concealed in steel enclosures, and the movable blades are operated by insulated levers on the front of the board. The equipment is called a dead-front switchboard.

15.7.4 Protective Devices for Circuits

In an electrical distribution system for a building, each electric service must have a means of disconnection, but it may not consist of more than six service switches. Each service switch may disconnect service to a panelboard from which lighter feeders extend to other distribution points, up to the final branch circuits with the minimum size wire, No. 12. This panelboard contains switches with lower disconnecting ratings than that of the service switch and that serve as disconnecting means for the light feeders. The rating and type of each switch must correspond to the size and kind of load and the wire size.

There must also be in every circuit some protective device to open the circuit if there is an unexpected overload, such as a short circuit or a jammed motor that prolongs a high inrush current. These protective devices may be fuses combined with knife switches, or circuit breakers, which provide both functions in one device. In addition, electrical systems should be protected against power surges caused by lightning strokes. See Art. 15.19.1.

Fuses in lighting and appliance circuits with loads up to 40 A may be the screwed plug type, with a metallic melting element behind a transparent top. For each rating, plug fuses are given different colors and the screw size is made intentionally different, to prevent errors.

Cartridge fuses are another type of fuse. They are cylindrical in form and are available in any size. They are classified for special purposes, and the rating is

clearly marked on the cylinder. So-called HI-CAP fuses (high capacity) are used for fused service switches that have the capacity to interrupt very high short-circuit currents.

Short circuits in the heavy copper conductor immediately following a service switch can be very high, because of the high power potential of the street transformers. The currents may be 25,000 to 100,000 A. Upon inquiry, the utility will advise as to the maximum short-circuit current for an installation. The service switch fuse should be selected to suit this capacity.

15.7.5 Circuit Breakers

Circuit breakers operate on a different principle. A circuit breaker is essentially a switch that is provided with means to sense a short circuit or overload and then to open the circuit immediately. Circuit breakers have ratings that are equal to the current, A, that will cause the breaker to trip. When a circuit breaker is closed, a spring is compressed that provides the energy to “trip” or open the circuit breaker on overload. In its simplest form, a circuit breaker senses an overload by means of a bimetallic element that expands from the heat caused by excessive current. Also, it senses a short circuit by means of a solenoid or coil. In either case, an internal mechanism releases the spring to trip the breaker. After the cause of the trip has been removed, the circuit breaker is simply reset. More sophisticated circuit breakers use current-sensing coils and either microprocessor-based trip units or protective relays to initiate breaker trip.

Both fuses and circuit breakers have time-current characteristics; that is, both will operate in a predictable time for a given current, and both will operate more quickly for a higher value of current. The importance of this is that fuses and circuit breakers must be selected and their time-current characteristics coordinated so that, if a short circuit or overload occurs, only the fuse or circuit breaker directly upstream will operate. This selectivity will isolate the problem without causing an unnecessary outage elsewhere in the building.

Current limiters may also be used at the service connection. These are strips of metal that have a high rate of increase in electrical resistance when heated. If a short circuit occurs, this limits the flow of short-circuit current even before the short is cleared.

Current-Limiting Reactors. A coil with high inductive reactance may be placed in series with the service. If a heavy short-circuit current occurs, the impedance limits the current by temporarily storing energy in the magnetic field.

15.7.6 Protective Relays

There are several kinds of faults that can occur in an electrical system. Over- or undervoltage, reverse flow of power, and excessive currents are but a few. Protective relays are available for application at critical locations in the electrical system to protect against these faults. Originally, protective relays were, and most still are, intricate electromechanical devices. However, many solid-state devices have been introduced that match the performance and dependability of the electromechanical relays.

Protective relays do not directly trip a breaker; they close a contact to provide an electrical signal to the breaker trip circuit. When protective relays are used to

trip a circuit breaker, it is always necessary to provide a source of electrical power, usually dc, from a battery bank at 48 V or 125 V, to provide tripping power.

15.7.7 Switchgear and Switchboards

The service switches and main distribution panelboards in large buildings are usually assembled in a specially designed steel frame housed in a separate electrical equipment room. The assembly is usually referred to as switchgear for large power units and switchboards for smaller assemblies.

A switchboard is defined in the National Electrical Code as a large single panel, frame, or assembly of panels, on which are mounted, on the face or back or both, switches, overcurrent and other protective devices, buses, and usually instruments. Switchboards are generally accessible from the rear as well as from the front and not intended to be installed in cabinets.

Switchboards are commonly divided into the following types:

1. Live-front.
2. Dead-front.
3. Safety enclosed switchboards.
 - a. Unit or sectional.
 - b. Draw-out.

Live-front switchboards have the current-carrying parts of the switch equipment mounted on the exposed front of the vertical panels. They are encountered only in existing installations and are now never used for new work.

Dead-front switchboards have no live parts mounted on the front of the board and are used in systems limited to a maximum of 600 V for dc and 2500 V for ac.

Unit safety-type switchboard is a metal-enclosed switchgear consisting of a completely enclosed self-supporting metal structure, containing one or more circuit breakers or switches.

Draw-out type switchboard is a metal-clad switchgear consisting of a stationary housing mounted on a steel framework and a horizontal draw-out circuit-breaker structure. The equipment for each circuit is assembled on a frame forming a self-contained and self-supporting mobile unit.

Metal-clad switchgear consists of a metal structure completely enclosing a circuit breaker and associated equipment such as current and potential transformers, interlocks, controlling devices, buses, and connections.

Because the switchboard room contains a heavy concentration of power, these rooms have special building-code requirements for ventilation and safety. The safety rules may require two exits remote from each other and minimum clear working spaces at front, top, back, and sides of the equipment. Also, the rules prohibit overhead piping and ducts above the equipment.

15.7.8 Substations

These are arrangements of transformers and switchgear used to step down voltages and connect to or disconnect from the mains. A master substation may be used to transform from utility-company high voltage down to 13,800 V or 4160 V for distribution. A load-center substation may be used to reduce to 600 V or less for

customer use. The load-center substation may be located outside the building in an underground vault or on a surface pad. Where street space is limited, utilities sometimes permit inside substations in the cellar of the customer adjacent to the switchboard room. These inside vaults must comply with strict rules for ventilation and drainage set by the utility, and access should be available from the street through doors that are normally locked.

15.7.9 Panelboards

These are distribution centers that are fed from the service switches and switchgear. A panelboard is a single panel or a group of panel units designed for assembly in the form of a single panel in which are included buses and perhaps switches and automatic overcurrent protective devices for control of light, heat, or power circuits of small capacity. It is designed to be placed in a cabinet or cutout box placed in or against a wall or partition and accessible only from the front. In general, panelboards are similar to but smaller than switchboards.

A panelboard consists of a set of copper mains from which the individual circuits are tapped through overload protective devices or switching units.

Panelboards are designed for dead-front construction, with no live parts exposed when the door of the panelboard is opened. Panelboards also are designed for flush, semiflush, or surface mounting. They fall into two general classifications, those designed for medium loads, usually required for lighting systems, and those for heavy-duty industrial-power-distribution loads.

Distribution panelboards are designed to distribute current to lighting panelboards and power loads and panelboards. Lighting panelboards are generally used for distribution of branch lighting circuits. Power panelboards fall into the following types:

1. Dead-front, fusible switch in branches
2. Dead-front, circuit breaker in branches

Since motors fed from power panelboards vary in sizes, the switches and breakers in a power panelboard are available in several different sizes corresponding to the rating of the equipment.

Panelboards are designed with mains for distribution systems consisting of:

1. Three-wire, single-phase 240/120-V, solid-neutral, alternating current
2. Three-wire, 240/120-V, solid-neutral, direct current
3. Four-wire, three-phase, 208/120-V, solid-neutral, alternating current
4. Four-wire, three-phase, 480/277-V, solid-neutral, alternating current

The mains in the panelboard may be provided with lugs only, fuses, switch and fuses, or circuit breakers.

A single-phase, three-wire panelboard consists of two copper busbars set vertically in the center of the panel and horizontal strip connections on each side for branch circuit breakers or switches. The third wire, or neutral, is connected to a copper plate at the top of the panel with several bolted studs. Neutral-wire connectors from each circuit are connected to that plate.

A similar construction is used for three-phase, four-wire panelboards, which are used for lighting, receptacle, and motor circuits, but with three, instead of two, copper busbars set vertically in the center of the board. Single-phase circuits may

be taken from both types of panelboards, but it is important to balance the loads as closely as possible on the two- or three-phase legs, to minimize the current in the neutral.

The following items should be taken into consideration in determining the number and location of panelboards:

1. No lighting panelboard should exceed 42 single-pole protective devices.
2. Panelboards should be located as near as possible to the center of the load it supplies.
3. Panelboards should always be accessible.
4. Voltage drop to the farthest outlet should not exceed 3%.
5. Panelboards should be located so that the feeder is as short as possible and have a minimum number of bends and offsets.
6. Spare circuit capacity should be provided at the approximate rate of one spare to every five circuits originally installed.
7. At least one lighting panelboard should be provided for each floor of a building.

Care should be taken when specifying panelboards to make sure that they are rated for the available short-circuit current. The panelboard bus bars must be physically braced to withstand the forces resulting from the flow of short-circuit current, and the fuses or circuit breakers must be capable of interrupting a downstream short circuit. Some panelboards are available with “integrated” or “series” short-circuit ratings, which indicate that even though the branch breakers cannot interrupt the available current, the panelboard main breaker can do so before any damage is done to the branch breakers. Such equipment can be less expensive than a fully rated panelboard, but the loss of selectivity for critical applications offsets the savings.

15.7.10 Motor Control Centers

These are an assembly, in one location, of motor controllers, devices that start and stop motors and protect them against overloads, and of disconnect switches for the motors. For safety reasons, the National Electrical Code requires that a disconnect switch be located within sight of the motor and its controller. In a motor control center, the disconnect switch is integral to the controller and may be a fusible switch, circuit breaker, or motor circuit protector.

The controller basically is a contactor, operated by a solenoid and returned to its normal position by a spring. The initiating device contacts may either be normally closed or normally open, depending on the automatic function required. Usually, an on-off-automatic selector switch is installed to control the contactor and allow manual operation of the motor for testing purposes and then return to automatic for normal functioning. Overload protection is incorporated in the contactor. For the purpose, thermal, heat-operated relays are provided. A reset button is pushed to close the switch after the overload has been removed.

In addition to motor-starting contactors, motor control centers may also contain variable frequency controllers for motors requiring speed control. Containing electronics to convert the constant 60-Hz utility power to a variable frequency output ranging from 1.5 to 120 Hz, they can control motor speed over the same range since ac motor speed is proportional to the frequency.

For certain industrial process applications, motor control centers may be provided with microprocessor-based programmable logic controllers (PLC). These can

control the operation of a single system or be integrated into a large, plantwide process control system.

15.8 ELECTRICAL DISTRIBUTION IN BUILDINGS

The National Fire Protection Association “National Electrical Code” is the basic safety standard for electrical design for buildings in the United States and has been adopted by reference in many building codes. In some cases, however, local codes may contain more restrictive requirements. The local ordinance should always be consulted.

The “National Electrical Code,” or the “National Electrical Code Handbook,” which explains provisions of the code, may be obtained from NFPA, 1 Battery March Park, Quincy, MA 02269-9101.

The American Insurance Association sponsors the Underwriters Laboratories, Inc., which passes on electrical material and equipment in accordance with standard test specifications. The UL also issues a semiannual List of Inspected Electrical Appliances, which can be obtained from the UL at 333 Pfingsten Road, Northbrook, IL 60062-2096.

Electrical codes and ordinances are written primarily to protect the public from fire and other hazards to life. They represent minimum safety standards. Strict application of these codes will not, however, guarantee satisfactory or even adequate performance. Correct design of an electrical system, over these minimum safety standards, to achieve a required level of performance, is the responsibility of the electrical designer.

15.8.1 Electrical Symbols

Table 15.1 illustrates the graphic symbols commonly used for electrical drawings for building installations. ANSI Y32.2, American National Standards Institute, contains an extensive compilation of such symbols.

15.8.2 Building Wiring Systems

The electrical load in a building is the sum of the loads, in kilowatts (kW), for lighting, motors, and appliances. It is highly unlikely, however, that all electrical loads in a building will be at full rated capacity at the same time. Hence, for economic selection of the electrical equipment in a building, demand and coincidence factors should be applied to the total connected load.

The **demand factor** is the ratio of the actual peak load of equipment or system to its maximum rating. An air-conditioning fan, for example, may require 8 hp at maximum load, but it will have a 10-hp motor (the standard available size). Therefore, its demand factor is 8/10. Lighting fixtures in a building, in contrast, can only operate at full load, or at a demand factor of 1.0.

The **coincidence factor** is the ratio of the maximum demand load of a system to the sum of the demand loads of its individual components and indicates the largest portion of all the electrical loads likely to be operating at one time. **Diversity factor** is the multiplicative inverse of the coincidence factor. Demand factors and

TABLE 15.1 Electrical Symbols*

Wall	Ceiling	
○	○	Outlet
⊖	⊖	Blanked outlet
	⊖	Drop cord
⊖	⊖	Electrical outlet—for use only when circle used alone might be confused with columns, plumbing symbols, etc.
⊖	⊖	Fan outlet
⊖	⊖	Junction box
⊖	⊖	Lamp holder
⊖ _{PS}	⊖ _{PS}	Lamp holder with pull switch
⊖	⊖	Pull switch
⊖	⊖	Outlet for vapor-discharge lamp
⊖	⊖	Exit-light outlet
⊖	⊖	Clock outlet (specify voltage)
⊖		Duplex convenience outlet
⊖ _{1,3}		Convenience outlet other than duplex. 1 = single, 3 = triplex, etc.
⊖ _{WP}	⊖	Weatherproof convenience outlet
⊖ _R		Range outlet
⊖ _S		Switch and convenience outlet
⊖ _R		Radio and convenience outlet
⊖		Special-purpose outlet (designated in specifications)
⊖		Floor outlet
S		Single-pole switch
S ₂		Double-pole switch
S ₃		Three-way switch
S ₄		Four-way switch
S _D		Automatic door switch
S _E		Electrolier switch
S _K		Key-operated switch
S _P		Switch and pilot lamp
S _{CB}		Circuit breaker
S _{WCB}		Weatherproof circuit breaker
S _{MC}		Momentary-contact switch
S _{RC}		Remote-control switch
S _{WP}		Weatherproof switch
S _F		Fused switch
S _{WF}		Weatherproof fused switch

TABLE 15.1 Electrical Symbols* (Continued)









































Wall	Ceiling
	Any standard symbol as given above with the addition of a lower-case subscript letter may be used to designate some special variation of standard equipment of particular interest in a specific set of architectural plans. When used, they must be listed in the key of symbols on each drawing and if necessary further described in the specifications
	
	
	Lighting panel
	Power panel
	Branch circuit; concealed in ceiling or wall
	Branch circuit; concealed in floor
	Branch circuit; exposed
	Home run to panelboard. Indicate number of circuits by number of arrows. NOTE: Any circuit without further designation indicates a two-wire circuit. For a greater number of wires indicate as follows: / / / (three wires), / / / / (four wires), etc.
	Feeders. NOTE: Use heavy lines and designate by number corresponding to listing in feeder schedule
	Underfloor duct and junction box. Triple system. NOTE: For double or single systems eliminate one of two lines. This symbol is equally adaptable to auxiliary-system layouts
	Generator
	Motor
	Instrument
	Power transformer (or draw to scale)
	Controller
	Isolating switch
	Push button
	Buzzer
	Bell
	Annunciator
	Outside telephone
	Interconnecting telephone
	Telephone switchboard
	Bell-ringing transformer
	Electric door opener
	Fire-alarm bell
	Fire-alarm station
	City fire-alarm station
	Fire-alarm central station

TABLE 15.1 Electrical Symbols* (*Continued*)

Wall	Ceiling
	Automatic fire-alarm device
	Watchman's station
	Watchman's central station
	Horn
	Nurse's signal plug
	Television antenna outlet
	Radio outlet
	Signal central station
	Interconnection box
	Battery
	Auxiliary-system circuits. NOTE: Any line without further designation indicates a two-wire system. For a greater number of wires designate with numerals in manner similar to 12—No. 18W-3/4"-C., or designate by number corresponding to listing in schedule.
	Special auxiliary outlets. Subscription letters refer to notes on plans or detailed description in specifications.

*Standard electrical symbols are compiled in ANSI Y32.2, American National Standards Institute.

coincidence factors or diversity factors can be obtained from a number of sources, such as the NFPA "National Electrical Code."

Motor and appliance loads usually are taken at full value. Household and kitchen appliances, however, are exceptions. The National Electrical Code lists demand factors for household electric ranges, ovens, and clothes dryers. Some municipal codes allow the first 3000 W of apartment appliance load to be included with lighting load and therefore to be reduced by the factor applied to lighting.

For factories and commercial buildings, the electrical designer should obtain from the mechanical design the location and horsepower of all blowers, pumps, compressors, and other electrical equipment, as well as the load for elevators, boiler room, and other machinery. The load in amperes for running motors is given in Tables 15.8 and 15.9.

15.8.3 Plans

Electrical plans should be drawn to scale, traced or reproduced from the architectural plans. Architectural dimensions may be omitted except for such rooms as meter closets or service space, where the contractor may have to detail his equipment to close dimensions. Floor heights should be indicated if full elevations are not given. Locations of windows and doors should be reproduced accurately, and door swings shown, to facilitate location of wall switches. For estimating purposes, feeder or branch runs may be scaled from the plans with sufficient accuracy.

Electrical plans may be drawn manually or by using a computer-aided drafting and design (CADD) system. Although a significant initial investment is required,

CADD can make the preparation of drawings fast and efficient and can make the interchange of information between electrical and the other engineering disciplines much easier.

Indicate on the plans by symbol the location of all electrical equipment (Table 15.1). Show all ceiling outlets, wall receptacles, switches, junction boxes, panelboards, telephone and interior communication equipment, fire alarms, television master-antenna connections, etc.

A complete set of electrical plans should include a diagram of feeders, panel lists, service entrance location, and equipment. Before these can be shown on the plans, however, wire sizes should be computed in accordance with procedures outlined in the following paragraphs.

Where there is only one panelboard in an area, and it is clear that all circuits in that area connect to that box, it is not necessary to number the panel other than to designate it as, for example, "apartment panel." In larger areas, where two or more panelboards may be needed, each should be labeled for identification and location; for example, L.P. 1-1, L.P. 1-2 . . . for all panelboards on the first floor; L.P. 2-1, L.P. 2-2 . . . for panels on the second floor.

15.8.4 Branch Circuits

It is good practice to limit branch runs to a maximum of 50 ft for 120-V circuits and 100 ft for 277-V circuits by installing sufficient panelboards in efficient locations.

Connect each outlet with a branch circuit and show the home runs to the panelboard, as indicated in Table 15.1. General lighting branch circuits with a 15-A fuse or circuit breaker in the panelboard usually are limited to 6 to 8 outlets, although most codes permit 12. No more than two outlets should be connected in a 20-A appliance circuit.

It is good practice to use wire no smaller than No. 12 in branch circuits, though some codes permit No. 14. Special-purpose individual branch circuits for motors or appliances should be sized to suit the connected load.

15.8.5 Electric Services

For economy, alternating current is transmitted long distances at high voltages and then changed to low voltages by step-down transformers at the point of service.

Small installations, such as one-family houses, usually are supplied with three-wire service. This consists of a neutral (transformer midpoint) and two power wires with voltage differing 180° in phase. From this service, the following types of interior branch circuits are available:

Single-phase two-wire 230-V—by tapping across the phase wires

Single-phase two-wire 115-V—by tapping across one phase wire and the neutral

Single-phase three-wire 115/230-V—by using both phase wires and the neutral

For larger installations, the service may be 480/277-V or 208/120-V, three-phase four-wire system. This has a neutral and three power wires carrying voltage differing 120° in phase. From this service, the following types of interior branch circuits are available:

- Single-phase two-wire 480-V or 208-V—by tapping across two phase wires
- Single-phase two-wire 277-V or 120-V—by tapping across one phase wire and the neutral
- Two-phase three-wire 480/277-V or 208/120-V—by using two phase wires and the neutral
- Three-phase three-wire 480-V or 208-V—by using three phase wires
- Three-phase four-wire 480/277-V or 280/120-V—by using three phase wires and the neutral

15.9 CIRCUIT AND CONDUCTOR CALCULATIONS

The current in a conductor may be computed from the following formulas, in which

- I = conductor current, A
- W = power, W
- f = power factor, as a decimal
- E_p = voltage between any two phase legs
- E_g = voltage between a phase leg and neutral, or ground

Single-phase two-wire circuits:

$$I = \frac{W}{E_p f} \quad \text{or} \quad I = \frac{W}{E_g f} \quad (15.24)$$

Single-phase three-wire (and balanced two-phase three-wire) circuits:

$$I = \frac{W}{2E_g f} \quad (15.25)$$

Three-phase three-wire (and balanced three-phase four-wire) circuits:

$$I = \frac{W}{3E_g f} \quad (15.26)$$

When circuits are balanced in a three-phase four-wire system, no current flows in the neutral. When a three-phase four-wire feeder is brought to a panelboard from which single-phase circuits will be taken, the system should be designed so that under full load the load on each phase leg will be nearly equal.

15.9.1 Voltage-Drop Calculations

Voltage drop in a circuit may be computed from the following formulas, in which

- V_d = voltage drop between any two phase wires, or between phase wire and neutral when only one phase wire is used in the circuit
- I = current, A
- L = one-way run, ft

R = resistance, $\Omega/\text{mil-ft}$
 c.m. = circular mils

Single-phase two-wire (and balanced single-phase three-wire) circuits:

$$V_d = \frac{2RIL}{\text{c.m.}} \quad (15.27)$$

Balanced two-phase three-wire, three-phase three-wire, and balanced three-phase four-wire circuits:

$$V_d = \frac{\sqrt{3} RIL}{\text{c.m.}} \quad (15.28)$$

Equations (15.27) and (15.28) contain a factor R that represents the resistance in ohms to direct current of 1 mil-ft of wire. The value of R may be taken as 10.7 for copper and 17.7 for aluminum. Tables in the National Fire Protection Association "National Electrical Code Handbook" give the resistance, ohms per 1000 ft, for various sizes of conductors. For small wire sizes, up to No. 3, resistance is the same for alternating and direct current. But above No. 3, ac resistance is larger, and this value as given in the handbook should be applied.

Voltage drops used in design may range from 1 to 5% of the service voltage. Some codes set a maximum for voltage drop of 2.5% for combined light and power circuits from service entry to the building to point of final distribution at branch panels.

When this voltage drop is apportioned to the various parts of the circuit, it is economical to assign the greater part, say 1.5 to 2%, to the smaller, more numerous feeders, and only 0.5 to 1% to the heavy main feeders between the service and main distribution panels. Tables in the NFPA handbook give the maximum allowable current for each wire size for copper and aluminum wire and the area, in circular mils, to be used in the voltage-drop formulas.

First, select the minimum-size wire allowed by the building code, and test it for voltage drop. If this drop is excessive, test a larger size, until one is found for which the voltage drop is within the desired limit. This trial-and-error process can be shortened by first assuming the desired voltage drop, and then computing the required wire area with Eqs. (15.27) and (15.28). The wire size can be selected from the handbook tables.

For circuits designed for motor loads only, no lighting, the maximum voltage drop may be increased to a total of 5%. Of this, 1% can be assigned to branch circuits and 4% to feeders.

Tables in the handbook also give dimensions of trade sizes of conduit and tubing and permissible numbers of conductors that can be placed in each size.

15.9.2 Wiring for Motor Loads

Motors have a high starting current that lasts a very short time. But it may be 4 to 6 times as high as the rated current when running. Although motor windings will not be damaged by a high current of short duration, they cannot take currents much greater than the rated value for long periods without excessive overheating and consequent breakdown of the insulation.

Overcurrent protective devices, fuses and circuit breakers, should be selected to protect motors from overcurrents of long duration, and yet permit short-duration

TABLE 15.2 Protection of Single-Phase Motors and Circuits

Size of motor		Branch-circuit protection*		Motor-running protection†				Size of fused switch or fuse holder		Minimum size of starter: NEMA size	Minimum size and type of wire: AWG or MCM	Minimum size of conduit: diameter, in
								Maximum size fuse permitted by the code	Time-delay-cartridge or low-peak fuse that can be used			
Horsepower	Ampere rating	Ordinary service	Heavy service	Maximum size								
				40°C motor	All other motors							
115 V												
1/6	4.4	15	7	4½	5	5 ⁵ / ₁₀	5 ⁵ / ₁₀					
1/4	5.8	20	10	5 ⁵ / ₁₀	6¼	8	7	30	30	00	14 R	½
1/3	7.2	25	12	7	8	9	9					
1/2	9.8	30	17½	10	12	12	12	30	30	0	14 R	½
¾	13.8	45	25	15	17½	17½	17½	60	30			
1	16	50	30	17½	20	20	20	60	30	0	12 R	½
1½	20	60	30	20	25	25	25	60	30			
2	24.0	80	40	25	30	30	30	100	60	1	10 R	¾

TABLE 15.2 Protection of Single-Phase Motors and Circuits (*Continued*)

Size of motor		Branch-circuit protection*		Motor-running protection†				Size of fused switch or fuse holder		Minimum size of starter: NEMA size	Minimum size and type of wire: AWG or MCM	Minimum size of conduit: diameter, in
								Maximum size fuse permitted by the code	Time-delay-cartridge or low-peak fuse that can be used			
		Ordinary service	Heavy service	40°C motor	All other motors							
230 V												
1/8	2.2	15	3½	2¼	2½	2 ⁸ / ₁₀	2 ⁸ / ₁₀					
1/4	2.9	15	5	2 ⁸ / ₁₀	3 ² / ₁₀	4	3½	30	30	00	14 R	½
1/3	3.6	15	6	3½	4	4½	4½					
1/2	4.9	15	8	5	5 ⁵ / ₁₀	6¼	6¼					
¾	6.9	25	12	7	8	9	8	30	30	00	14 R	½
1	8	25	15	8	9	10	10					
1½	10	30	17½	10	12	12	12	30	30			
2	12	40	20	12	15	15	15	60	30	0	14 R	½
3	17	60	25	17½	20	20	20	60	30	1	10 R	¾
5	28	90	45	30	35	35	35	100	60	2	8 R	¾
7½	40	125	60	40	45	50	50	200	60	2	6 R	1
10	50	150	80	50	60	70	60	200	100	3	4 R	1½

* These do not give motor-running protection.

† On normal installations these also give branch-circuit protection.

TABLE 15.3 Protection of Three-Phase 208-V Motors and Circuits

Size and class of motor			Branch circuit protection*		Motor-running protection†				Size of fused switch or fuse holder		Minimum size of starter: NEMA size	Minimum size and type of wire: AWG or MCM	Minimum size of conduit: diameter, in
			Maximum size fuse permitted by the code	Time-delay-cartridge or low-peak fuse that can be used	Size of time-delay-cartridge or low-peak fuse				Maximum size switch that can be used	Size that can be used with time-delay-cartridge or low-peak fuses			
Horse-power	Ampere rating	Class			Ordinary service	Heavy service	Maximum size				40°C motor	All other motors	
			½	2.1			Any	15	5	2¼			2½
¾	3	Any	15	8	3 ² / ₁₀	3½	4	3½					
1	3.7	Any	15	8	4	4½	5	4½	30	30	00	14 R	½
1½	5.3	Any	15	10	5 ⁵ / ₁₀	6¼	7	6¼					
2	6.9	1	25	12	7	8	9	8					
		2	20	12	7	8	9	8	30	30	0	14 R	½
		3-4	15	12	7	8	9	8					
3	9.5	1	30	15	10	12	12	12					
		2	25	15	10	12	12	12					
		3	20	15	10	12	12	12	30	30	0	14 R	½
		4	15	15	10	12	12	12					
5	15.9	1	50	25	17½	20	20	20	60	30			
		2	40	25	17½	20	20	20	60	30			
		3	35	25	17½	20	20	20	60	30	1	12 R	½
		4	25	25	17½	20	20	20	30	30			
7½	23.3	1	80	35	25	30	30	30	100	60			
		2	60	35	25	30	30	30	60	60			
		3	50	35	25	30	30	30	60	60	1	10 R	¾
		4	40	53	25	30	30	30	60	60			

TABLE 15.3 Protection of Three-Phase 208-V Motors and Circuits (Continued)

Size and class of motor			Branch circuit protection*	Motor-running protection†					Size of fused switch or fuse holder		Minimum size and type of wire: AWG or MCM	Minimum size of conduit: diameter, in		
				Maximum size fuse permitted by the code	Time-delay-cartridge or low-peak fuse that can be used	Size of time-delay-cartridge or low-peak fuse				Maximum size switch that can be used			Size that can be used with time-delay-cartridge or low-peak fuses	Minimum size of starter: NEMA size
						Ordinary service	Heavy service	40°C motor	All other motors					
Horse-power	Ampere rating	Class												
10	28.6	1	90	45	30	35	40	35	100	60	2	8 R	¾	
		2	70	45	30	35	40	35	100	60				
		3	60	45	30	35	40	35	60	60				
		4	45	45	30	35	40	35	60	60				
15	42.3	1	125	60	45	50	50	50	200	60	2	6 R	1	
		2	110	60	45	50	50	50	200	60				
		3	90	60	45	50	50	50	100	60				
		4	70	60	45	50	50	50	100	60				
20	55	1	175	90	60	70	70	70	200	100	3	4 R	1½	
		2	150	90	60	70	70	70	200	100				
		3	110	90	60	70	70	70	200	100				
		4	90	90	60	70	70	70	100	100				
25	68	1	225	100	70	80	90	80	400	100	3	2 R	1½	
		2	175	100	70	80	90	80	200	100				
		3	150	100	70	80	90	80	200	100				
		4	110	100	70	80	90	80	200	100				
30	83	1	250	125	90	100	110	100	400	200	3	1 R	1½	
		2	225	125	90	100	110	100	400	200				
		3	175	125	90	100	110	100	200	200				
		4	125	125	90	100	110	100	200	200				
40	110	1	350	175	110	125	150	150	400	200	4	0 RH	2	
		2	300	175	110	125	150	150	400	200				
		3	225	175	110	125	150	150	400	200				
		4	175	175	110	125	150	150	200	200				
50	132	1	400	200	150	175	175	175	400	200	4	00 RH	2	
		2	350	200	150	175	175	175	400	200				
		3	300	200	150	175	175	175	400	200				
		4	200	200	150	175	175	175	200	200				

TABLE 15.3 Protection of Three-Phase 208-V Motors and Circuits (*Continued*)

Size and class of motor			Branch circuit protection*	Motor-running protection†				Size of fused switch or fuse holder		Minimum size of starter: NEMA size	Minimum size and type of wire: AWG or MCM	Minimum size of conduit: diameter, in		
				Maximum size fuse permitted by the code	Time-delay-cartridge or low-peak fuse that can be used	Size of time-delay-cartridge or low-peak fuse		Maximum size switch that can be used	Size that can be used with time-delay-cartridge or low-peak fuses					
Horsepower	Ampere rating	Class	Ordinary service			Heavy service	Maximum size							
				40°C motor	All other motors									
60	159	1	500	250	175	200	200	200	600	400	5	000 RH	2	
		2	400	250	175	200	200	200	200	400				400
		3	350	250	175	200	200	200	200	400				400
		4	250	250	175	200	200	200	200	400				400
75	196	1	600	300	200	225	250	250	600	400	5	250 RH	2½	
		2	500	300	200	225	250	250	250	600				400
		3	400	200	200	225	250	250	250	400				400
		4	300	300	200	225	250	250	250	400				400
100	260	1		400	250	300	350	300		400	5	400 RH	3	
		2		400	250	300	350	300		400				400
		3	600	400	250	300	350	300	300	600				400
		4	400	400	250	300	350	300	300	400				400
125	328	1-3		500	350	400	450	400		600	6	2 sets‡	0000 RH	2½‡
		4	500	500	350	400	450	400	400	600				
150	381	1-3		600	400	450	500	450		600	6	2 sets‡	250 RH	2½‡
		4	600	600	400	450	500	450	450	600				

* These do not give motor-running protection.

† On normal installations these also give branch-circuit protection.

‡ Indicates two sets of multiple conductors and two runs of conduit.

starting currents to pass without disconnecting the circuit. For this reason, the National Electrical Code permits the fuse or circuit breaker in a motor circuit to have a higher ampere rating than the allowable current-carrying capacity of the wire. Tables in the NFPA handbook give the overcurrent protection for motors allowed by the Code and data on time-delay fuses that permit smaller fuse holders for a given-size motor than with standard fuses.

The National Electrical Code requirements for motor circuit conductors and overcurrent protection are as follows:

Branch Circuits (One Motor). Conductors shall have an ampacity not less than 125% of the motor full-load current. Overcurrent protection, fuses or circuit breakers, must be capable of carrying the starting current of the motor. Maximum rating of such protection varies with the type, starting method, and locked-rotor current of the motor. For the great majority of motor applications in buildings, conductor and fuse protection may be selected from Tables 15.2 and 15.3.

Feeder Circuits (More than One Motor on a Conductor). The conductor should have an allowable current-carrying capacity not less than 125% of the full-load current of the largest motor plus the sum of the full-load currents of the remaining motors on the same circuit. The rating of overcurrent protection, fuses or circuit breakers, shall not be greater than the maximum allowed by the code for protection of the largest motor plus the sum of the full-load currents of the remaining motors on the circuit.

If the allowable current-carrying capacity of the conductor or the size of the computed overcurrent device does not correspond to the rating of a standard-size fuse or circuit breaker, the next larger standard size should be used.

Amp-Traps and Hi-Caps are high-interrupting-capacity current-limiting fuses used in service switches and main distribution panels connected near service switches. This type of fuse is needed here because this part of the wiring system in large buildings consists of heavy cables or buses and large switches that have very little resistance. If a short circuit occurs, very high currents will flow, limited only by the interrupting capacity of the protective device installed by the utility company on its own transformers furnishing the service. Ordinary fuses cannot interrupt this current quickly enough to avert damage to the building wiring and connected electrical equipment. The interrupting-capacity value needed can be obtained from the utility company.

Fuses in service switches and connected main panels should have current-time characteristics that will isolate only the circuit in which a short occurs, without permitting the short-circuit current to pass to other feeders and interrupt those circuits too. The electrical designer should obtain data from manufacturers of approved fusing devices on the proper sequence of fusing.

15.9.3 Service-Entrance Switch and Metering Equipment

Fused switches or circuit breakers must be provided near the entrance point of electrical service in a building for shutting off the power. The National Electrical Code requires that each incoming service in a multiple-occupancy building be controlled near its entrance by not more than six switches or circuit breakers.

Metering equipment consists of a meter pan, meter cabinet, current transformer cabinet, or a combination of these cabinets, depending on the load requirements and other characteristics of the specific project. The meters and metering transform-

ers for recording current consumed are furnished by the utility company. Unless otherwise permitted by the utility company, meters must be located near the point of service entrance. Sometimes, the utility company permits one or more tenant meter rooms at other locations in the cellar of an apartment house to suit economical building wiring design. Tenant meter closets on the upper floors, opening on public halls, also may be permitted. The most common form of tenant meters used is the three-wire type, consisting of two phase wires and the neutral, taken from a 208/120-V three-phase four-wire service.

The service switch and metering equipment may be combined in one unit, or the switch may be connected with conduit to a separate meter trough. For individual metering, the detachable-socket-type meter with prongs that fit into the jaws of the meter-mounting trough generally is used.

15.9.4 Switchboards and Panelboards

For low-capacity loads, wiring may be taken directly to a panelboard. For larger loads, wiring may be brought first to a switchboard and then to panelboards. This equipment is described in Art. 15.7. Branch circuits extend from panelboards to the various loads.

15.9.5 Sample Calculations for Apartment-Building Riser

A diagram of a light and power riser for a nine-story apartment building is shown in Fig. 15.10. Calculation of required wires and conduits may be carried out with the aid of tables in the NFPA "National Electrical Code Handbook."

1. *Typical Meter Branch to Apartment Panel.* Note that the meters are three-wire type, and three apartments are connected to the same neutral. Under balanced conditions, when each of the three identical apartments is under full load, no current will flow in the neutral. But at maximum unbalance, current in the neutral may be twice the current in the phase wire for any one apartment. The neutral wire must be sized for this maximum current, though the usual practice is to compute voltage drops for the balanced condition.

Assume that the apartment area is 900 ft². The one-way run from meter to apartment panel (apartment A) is 110 ft.

$$\begin{array}{rcl} \text{Apartment lighting load} & = & 900 \times 3 \text{ W/ft}^2 = 2700 \text{ W} \\ \text{Apartment appliance load} & & = \underline{3000} \\ \text{Total} & & = 5700 \text{ W} \end{array}$$

The electric service is three-phase four-wire 208/120 V. Thus, the voltage between phase wires is 208, and between one phase and neutral 120 V. Assume a 90% power factor. From Eq. (15.25):

$$\text{Current per phase} = \frac{5700}{2 \times 120 \times 0.9} = 26.4 \text{ A}$$

The local electrical code requires the minimum size of apartment feeder to be No. 8 wire. The allowable current in No. 8 RH wire is 45 A; so this wire would be adequate for the current, but it still must be checked for voltage drop. The neutral must be sized for the maximum unbalance, under which condition the current in the neutral will be $2 \times 26.4 = 52.8$ A. This will require No. 6 wire.

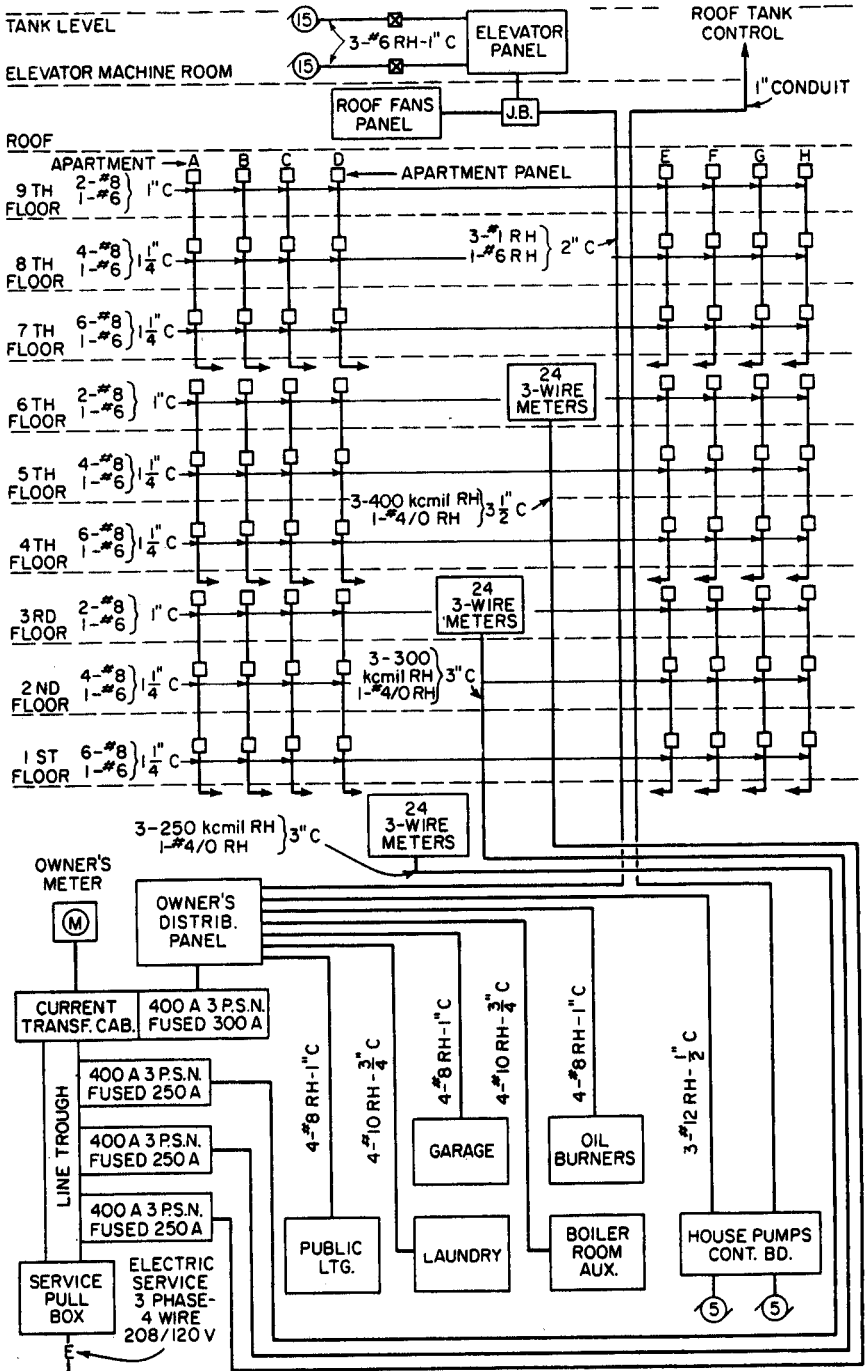

FIGURE 15.10 Diagram of a typical apartment-building electrical riser.

The voltage drop between phase wires can be obtained from Eq. (15.28), with the area of No. 8 wire taken as 16,510 circular mils and length of wire as 110 ft:

$$V_d = \frac{\sqrt{3} \times 10.7 \times 26.4 \times 110}{16,510} = 3.24 \text{ V}$$

$$\% \text{ voltage drop} = \frac{3.24 \times 100}{208} = 1.56\%$$

2. Feeder to Meter Bank on Sixth Floor.

Total load (24 apartments)	=	24 × 5700 W	=	136,800 W
Demand load: first 15,000 W at 100%	=	15,000		
Balance, 121,800 W at 50%	=	<u>60,900</u>		
Total demand load	=	75,900 W		

Assume a power factor of 90% and apply Eq. (15.26):

$$\text{Current per phase} = \frac{75,900}{3 \times 120 \times 0.9} = 234 \text{ A}$$

Minimum-size type RH wire for this current is 250 kcmil. This has to be tested for voltage drop. For a one-way run of 150 ft from service switch to sixth-floor meter bank and an area of 250,000 circular mils, Eq. (15.28) gives:

$$V_d = \frac{\sqrt{3} \times 10.7 \times 234 \times 150}{250,000} = 2.60 \text{ V}$$

The correction factor for ac resistance of 250-kcmil wire is 1.06. Application of this factor yields a corrected voltage drop of $1.06 \times 2.60 = 2.76$ volts.

$$\% \text{ voltage drop} = \frac{2.76 \times 100}{208} = 1.33\%$$

Then, the total voltage drop from service switch to apartment panel A is

$$1.56 + 1.33\% = 2.89\%$$

which exceeds the 2.5% maximum voltage drop allowed by the local code. It is necessary, therefore, to increase the size of the meter bank feeder over the minimum size required for the current.

To bring the total drop down to 2.5% the meter bank feeder drop must be reduced to 0.94% or 1.96 volts. The required wire size may be found by proportion:

$$\text{Required area} = \frac{2.76}{1.96} \times 250,000 = 352,000 \text{ circular mils}$$

The nearest larger wire size is 400 kcmil.

For computing the size of the neutral for carrying 234 A, the local code allows a demand factor of 70% on lighting loads over 200 A. Hence, the net current in the neutral is $200 + 34 \times 0.70 = 223.8$ A. Minimum-size wire is No. 4/0 RH. And the size of conduit required for the feeder is computed as follows with the aid of tables in the NFPA "National Electrical Code Handbook":

$$\begin{aligned}
 \text{Three 400-kcmil RH wires} &= 3 \times 0.8365 = 2.5095 \text{ in}^2 \\
 \text{One 0000 RH wire} &= \underline{0.4840} \\
 \text{Total area} &= 2.9935 \text{ in}^2
 \end{aligned}$$

Permissible raceway fill for four conductors is 40%. Hence the minimum area required for the conduit is $2.9935/0.40 = 7.484 \text{ in}^2$. And the required conduit size is $3\frac{1}{2}$ in.

3. *Feeder to Elevator and Roof Fans Panel.* The total load on this feeder is

$$\begin{aligned}
 8 \text{ roof fans at } \frac{1}{2} \text{ hp} &= 16.8 \text{ A/phase} \\
 8 \text{ roof fans at } \frac{1}{4} \text{ hp} &= 17.4 \\
 2 \text{ elevators at } 15 \text{ hp} &= \underline{84.6} \\
 \text{Total} &= 118.8 \text{ A/phase}
 \end{aligned}$$

The minimum current-carrying capacity of the feeder must be 125% of the rated full-load current of the largest motor, an elevator motor, 42.3 A, plus the sum of the rated load currents of the other motors. Thus, the capacity must be

$$1.25 \times 42.3 + 42.3 + 16.8 + 17.4 = 129.4 \text{ A}$$

The minimum-size wire that may be used is No. 1 RH, with an area of 83,690 circular mils.

Check for voltage drop with a run of 150 ft:

$$V_d = \frac{\sqrt{3} \times 10.7 \times 118.8 \times 150}{83,690} = 3.95 \text{ V}$$

$$\% \text{ voltage drop} = \frac{3.95 \times 100}{208} = 1.90\% \quad \text{OK}$$

15.9.6 Computerized Analysis

Personal computers and available electrical design software with a wide range of sophistication and comprehensiveness offer a very efficient method for performing electrical design calculations. Computers can perform the calculations required for sizing wires, conduits, transformers, and panelboards speedily and with freedom from computational errors. For more intricate and involved calculations, such as short-circuit analysis on a complex, multisource system, or determination of the voltage drop occurring when a very large motor starts, computers can reduce several days of manual work to a few hours. Computer programs are available for calculating ground resistance, power load flow, wire-pulling tensions, and time-current coordination of circuit breakers, relays, and fuses. There also are programs that interface directly with CADD software to produce calculations automatically while drawing the single-line diagrams.

15.10 LIGHT AND SIGHT

Lighting is part of the environmental control system, which also includes sound control and heating, ventilation, and air conditioning (HVAC), within a building.

The prime purpose of a lighting system is to provide good visibility for execution of the tasks to be performed within the building. With good visibility, occupants can execute their tasks comfortably, efficiently, and safely.

Lighting also is desirable for other purposes. For example, it can be used to develop color effects for pleasure or accident prevention. It can be used to decorate select spaces or to accent objects. It can produce effects that influence human moods. And it can serve to illuminate an emergency egress system and as part of a security system.

Good lighting requires good quality of illumination (Art. 15.11), proper color rendering (Art. 15.12), and an adequate quantity of light (Art. 15.13). This result, however, cannot be achieved economically solely by selection and arrangement of suitable light sources. Lighting effects are also dependent on other systems and factors such as the characteristics of surrounding walls, floor, and ceiling; nature of tasks to be illuminated; properties of the backgrounds of the tasks; age and visual acuity of occupants; and characteristics of the electrical system. Design of a lighting system, therefore, must take into account its interfacing with other systems. Also, lighting design must take into account the influence of lighting requirements on other systems, including architectural systems; heating and cooling effects of windows provided for daylighting; energy supply required from the electrical system; and loads imposed by electric lighting on the HVAC system.

Sources of light within a building may be daylight or artificial illumination. The latter can be produced in many ways, but only the most commonly used types of electric lighting are discussed in this section.

Like other building systems, lighting design is significantly affected by building codes. These generally contain minimum requirements for illumination levels, for the safety and health of building occupants. In addition, electric lighting equipment and electrical distribution must conform to safety requirements in building codes and the National Electrical Code, which is promulgated by the National Fire Protection Association, and to standards of the Underwriters Laboratories, Inc. Also, the Illuminating Engineering Society has developed standards and recommended practices to promote good lighting design.

In the interests of energy conservation, federal and state government agencies have set limits on the amount of energy that may be expended (energy budget) for operation of buildings. These limits may establish maximum levels of illumination for specific purposes in buildings.

Because of the importance of good lighting, the need to control lighting costs and to conserve energy, and the multiplicity of legal requirements affecting lighting design, engagement of a specialist in lighting design is advisable for many types of buildings.

15.10.1 Visibility

A light source produces light by converting energy to electromagnetic waves. Light sources used in practical applications emit waves with a broad spectrum of frequencies or wavelengths. Light consists of those waves that the human eye normally perceives. A normal eye interprets the wavelengths as colors, the shortest wavelengths being recognized as blue, the longest wavelengths as red, and intermediate wavelengths as green, yellow, and orange. The eye also recognizes differences in intensity of light, or levels of illumination.

The eye sees an object because it receives light emitted by the object (if it is a light source) or reflected from it (if the object is not a light source). In the latter

case, the eye can see the object if it reflects light received from a light source directly or from surfaces reflecting light. The total light reflected from the object equals the sum of the light from all sources that strikes the object and is not absorbed. Thus, an object shielded from light sources will be revealed to the eye by light reflected from other surfaces, such as walls, floor, ceiling, or furniture. The amount of detail on the object that the eye can recognize, however, depends not only on the intensity of light that the eye receives from the object but also on the intensity of that light relative to the intensity of light the eye receives from the background (field of vision behind the object). Consequently, the eye can readily recognize details on a brightly lit object set against a darker background. But the eye perceives little detail or considers the object dark (in shadow) if the background is much brighter than the object.

15.10.2 Inverse Square Law

Consider now a point source radiating luminous energy equally in all directions and located at the common center of two transparent spheres of unequal diameter. Because each sphere receives the same amount of luminous energy from the light source, the quantity of light per unit of area is less on the larger sphere than that on the smaller one. In fact, the quantity per unit area varies inversely as the areas of the spheres, or inversely as the square of the radii. These considerations justify the inverse square law, which states:

Illumination level at any point is inversely proportional to the square of distance from the point light source.

For large light sources, the law holds approximately at large distances (at least 5 times the largest dimension of the sources) from the sources.

15.10.3 Light Source Power

Analogous to a pump in a water system or a battery in an electrical system, a light source emits luminous power. The unit used to measure this power is **candlepower** (cp), or **candela** (cd) (metric unit). (At one time, 1 candlepower was assumed equivalent to the luminous intensity of a wax candle, but now a more precise definition based on radiation from a heated black body is used.) The unit used to measure luminous power at a distance from the light source is the lumen (lm).

A **lumen** is the luminous power on an area of 1 ft² at a distance of 1 ft from a 1-cp light source or, since 1 cp = 1 cd, on an area of 1 m² at a distance of 1 m from a 1-cd light source.

Luminous efficacy is the unit used to measure the effectiveness of light sources. It is calculated by dividing the total lumen output of a light source by the total input, watts (W), and thus is measured in lm/W.

15.10.4 Level of Illumination

A major objective of lighting design is to provide a specified **illuminance**, or level of illumination, on a task. For design purposes, the task often is taken as a flat

surface, called a **work plane**. If the task is uniformly illuminated, the level of illumination equals the lumens striking the surface divided by the area. The unit used to measure illuminance is the **footcandle** (fc) lm/ft^2 . In accordance with the inverse square law, the illuminance on a work plane normal to the direction to a point light source is given by

$$\text{fc} = \frac{\text{cp}}{D^2} \quad (15.29)$$

where D = distance, ft, from work plane to light source
 cp = candlepower of light source

For a work plane at an angle θ to the direction of the light source,

$$\text{fc} = \text{cp} \sin \frac{\theta}{D^2} \quad (15.30)$$

In the metric system, illuminance is measured in lux, or lm/m^2 ; $1 \text{ fc} = 10.764 \text{ lux}$.

A **luminaire** is a lighting device that consists of one or more lamps, or light sources, a fixture that positions and shields them, components that distribute the light, and elements that connect the lamps to the power supply. In general, luminaires do not radiate light of equal intensity in all directions, because of the characteristics of the lamps or the geometry of the fixtures. The actual illuminance around a single luminaire is an important design consideration. This environment may be characterized by the candlepower distribution curve of the luminaire. A typical such curve for a light source symmetrical about two vertical, perpendicular planes is shown in Fig. 15.11.

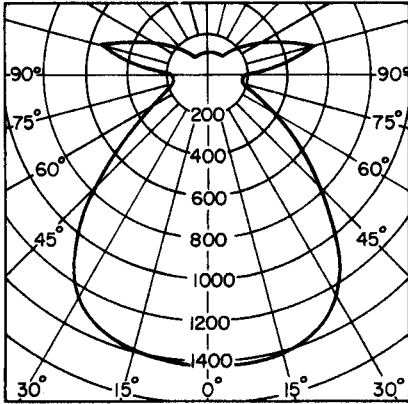

FIGURE 15.11 Candlepower distribution curve indicates variation in lighting intensity with direction from a light source.

(15.29), the candlepower corresponding to the illuminance at each point is computed. In practice, the candlepower is usually calculated for points in vertical planes along longitudinal and transverse axes through the luminaire. The results for each plane are then plotted with polar or rectangular coordinates relative to the light source. Such plots show the variation in illuminance with direction from the light source. For example, Fig. 15.11 shows in polar coordinates that the light source investigated directs light mainly downward. Because the source is symmetrical, only one curve is needed in this case to represent illuminance in longitudinal, transverse, and diagonal planes.

To produce the curve, illuminance, fc , is measured, with a goniophotometer, on a plane that is placed at various points at equal distances from the light source and that at each point is normal to the direction to the source. From Eq.

15.10.5 Equivalent Spherical Illumination

If proper care is not taken in positioning observer and task relative to primary light sources, one or more of these light sources may be reflected into the field of vision as from a mirror. The resulting glare reduces visibility of the task; that is, effective illuminance, f_c , is less than the raw (actual) footcandles. For measurement of the effective illuminance of lighting installations, the concept of equivalent spherical illumination, ESI f_c , was introduced. It is based on a standard sphere lighting that produces equal illumination from all directions (almost glarefree). In employment of the ESI concept, an actual lighting installation is assumed replaced by sphere illumination with task visibility equivalent to that of the actual installation.

15.10.6 Brightness

As mentioned previously, an observer sees an object because of light reflected from it. The observer interprets the intensity of the sensation experienced as brightness. The sensation of brightness usually is partly attributable to the general luminous environment, which affects the state of adaptation of the eye, and partly attributable to the intensity of light emanating from the object. The latter component is called luminance, or photometric brightness.

Luminance is the luminous power emitted, transmitted, or reflected by a surface in a given direction, per unit of area of the surface projected on a plane normal to that direction. The unit of measurement of luminance is the footlambert (cd/m^2 in the metric system).

A **footlambert** (fL) of luminance in a given direction is produced by one lumen per square foot emanating from a surface in that direction. Thus, a self-luminous surface emitting $10 \text{ lm}/\text{ft}^2$ has a luminance of 10 fL. For surfaces that reflect or transmit light, however, luminance depends both on the illuminance of light incident on the surface and characteristics of the surface.

For a reflecting surface, luminance is determined from

$$\text{fL} = f_c \times \text{reflectance} \quad (15.31)$$

where f_c = footcandles of incident light. A mirror (specular reflector) may give almost 100% reflection, whereas a black surface absorbs light and therefore has negligible reflectance. Most materials have an intermediate value of reflectance.

For a transmitting surface, luminance is determined from

$$\text{fL} = f_c \times \text{transmittance} \quad (15.32)$$

Clear glass (transparent material) may have a transmittance of about 90%, whereas an opaque material has no transmittance. Transmittances of other transparent materials may be about the same as that for clear glass, while transmittances of translucent materials may be 50% or less. Light incident on a surface and not reflected or transmitted is absorbed by it.

In general, visibility improves with increase in brightness of a task. Because increase in brightness is usually accomplished at increase in operating cost caused by consumption of electric power, it is neither necessary nor desirable, however, to maintain levels of illumination higher than the minimum needed for satisfactory performance of the task. For example, tests show that speed of reading and comprehension are nearly independent of illuminance above a minimum level. This level depends on several factors, such as difficulty of the task, age of observers,

duration of the task, and luminance relation between task and its surroundings. The more difficult the task, the older the occupants, and the longer the task, the higher the minimum level of illumination should be.

High brightness also is useful in attracting visual attention and accenting texture. For this reason, bright lights are played on merchandise and works of art.

15.10.7 Contrast

This is created when the brightness of an object and its surroundings are different. The effects of contrast on visibility depend on several factors but especially on the ratio of brightness of object to that of its background. Ideally, the brightness of a task should be the same as that of its background. A 3:1 brightness ratio, however, is not objectionable; it will be noticed but usually will not attract attention. A 10:1 brightness ratio will draw attention, and a brightness ratio of 50:1 or more will accent the object and detract attention from everything else in the field of vision.

High background brightness, or low brightness ratios, may have adverse or beneficial effects on visibility. Such high contrast is undesirable when it causes glare or draws attention from the task or creates discordant light and dark patterns (visual noise). On the other hand, high contrast is advantageous when it helps the observer detect task details; for example, read fine print. High contrast makes the object viewed appear dark so that its size and silhouette can be readily discerned. But under such circumstances, if surface detail on the object must be detected, object brightness must be increased at least to the level of that of the background.

The reason for this is that the eye adapts to the brightness of the whole field of vision and visualizes objects in that field with respect to that adaptation level. If background brightness is disturbing, the observer squints to reduce the field of vision and its brightness and thus increase the brightness of the task. The need for squinting is eliminated, however, by increasing the illumination on the task.

15.10.8 Effects of Colored Lights

Color of light affects the color of an object (color rendering), because the surface of the object absorbs light of certain frequencies and reflects light of other frequencies. An object appears red because it reflects only red light and absorbs other hues. If a light source emits light that is only blue-green, the color complementary to red, the red object will reflect no light and will therefore appear to be gray. The eye, however, can, to some degree, recognize colors of objects despite the color of the illuminant; that is, the eye can adapt to colored light. It also becomes sensitive to the colors that would have to be added to convert the illuminant to white light.

Apparent color is also affected by high levels of illumination. For example, all colors appear less bright, or washed out, under high illumination. But brightness of color also depends on the hue. Under the same illumination, light colors appear brighter than dark colors. Thus, lower levels of illumination are desirable with white-, yellow-, and red-colored (warm-colored) objects than with black-, blue-, and green-colored (cool-colored) objects. (Warm-colored objects also have the psychological effect of appearing to be closer than they actually are, whereas cool-colored objects tend to recede. In addition, cool colors create a calm and restful atmosphere, conducive to meditation, but are not flattering to skin colors or food, whereas warm colors produce opposite effects.)

See also Arts. 15.12, Color Rendering, and 15.20, Bibliography.

15.11 QUALITY OF LIGHT

A good lighting system not only provides adequate quantities of light for safe, efficient visual performance but also good quality of light. Quality determines the visual comfort of building occupants and contributes to good visibility. In accordance with the relationships between light and sight described in Art. 15.10, quality and quantity therefore should be considered together in lighting design. For ease of presentation, however, the factors affecting these characteristics of light are discussed separately. Color rendering is treated in Art. 15.12 and quantity of light, in Art. 15.13.

The characteristics of a luminous environment that determine quality are contrast, diffusion, and color rendering. Contrast, created by shadows or by relatively bright areas in a field of vision, affects visibility, mood, comfort, and eyestrain (Art. 15.10). Diffusion, the dispersion of light in all directions, may be produced by transmission or reflection. Diffuse transmission occurs when light from a bright source passes through a material that disperses the incident light, with consequent reduction in brightness. Translucent materials or specially constructed lenses are often employed for this purpose in lighting fixtures. Diffuse reflection occurs when incident light on a surface is reflected almost uniformly in all directions by tiny projections or hollows. Such surfaces appear nearly equally bright from all viewing angles. Diffusion tends to reduce contrast and promote uniformity of lighting.

Brightness Ratios. For good quality of lighting, the degree of contrast of light and dark areas in the field of vision should be limited to provide for viewing angle changes. The reason for this is that the eye adapts to the luminance of a task after a period of time. When the eye leaves the task and encounters a field of different brightness, the eye requires an appreciable time to adapt to the new condition, during which eyestrain or visual discomfort may be experienced. To promote quick, comfortable adaptation, brightness ratios in the visual environment should be kept small.

For example, in offices, the ratio of brightness of task to that of darker immediate surroundings should not exceed 3:1, and to that of darker, more remote surroundings, 5:1. Similarly, the ratio of brightness of lighter, more remote surroundings to that of the task should be less than 5:1. (See "Office Lighting," RP 1, Illuminating Engineering Society of North America, 345 E. 47th St., New York, NY 10017-2377.)

Direct Glare. When background luminance is much greater than that of the task, glare results. It may take the form of direct glare or reflected glare. Direct glare is produced when bright light sources are included in the field of vision and cause discomfort or reduced visibility of the task. The intensity of glare depends on the brightness, size, and relative position of the light sources in the field of vision, and on the general luminance of the field of vision.

The brighter the light source, the greater will be the glare, other factors remaining substantially constant. Similarly, the larger the light source, the greater will be the glare. A small bright lamp may not be objectionable; in fact, in some cases, it may be desirable to provide sparkle and relieve the monotony of a uniformly lit

space, whereas a large, bright luminaire in the field of vision would cause discomfort. In contrast, glare decreases as the distance of the light source from the line of sight increases. Also, glare decreases with increase in general luminance of the visual environment, or level of eye adaptation.

The Illuminating Engineering Society has established standard conditions for determining a criterion, called **visual comfort probability (VCP)**, for rating discomfort glare. VCP indicates the percentage of observers with normal vision who will be visually comfortable in a specific environment. Tables of VCP values for various luminaires are available from their manufacturers. VCP values should be applied with caution, because they may not be applicable under conditions that depart significantly from the IES standard.

In general, direct glare should not be troublesome if all of the following conditions are satisfied for an overhead electric lighting system:

1. VCP is about 70 or more.
2. The ratio of maximum luminance of each luminaire to its average luminance is 5:1 (preferably 3:1) or less, at 45, 55, 65, 75, and 85° with respect to the vertical, when viewed lengthwise and crosswise.
3. The maximum luminance of each luminaire, when viewed lengthwise and crosswise, does not exceed the values given in Table 15.4 for the specified angles.

Reflected Glare. Also called veiling reflection because of the effect on visibility, reflected glare results when incident light from a bright light source is reflected by the task into the eyes of the observer and causes discomfort or loss of contrast. Occurrence of glare depends on the brightness of the light source, overall luminance of the task, reflectance of the task surface, and relative positions of light source, task, and observer. When a bright light source is reflected into an observer's eyes, it casts an apparent veil over the image of the task. The result is a loss of contrast that would otherwise be useful in perception of task size and silhouette details; for example, print that would be readily legible without reflected glare would become difficult to read in the presence of a veiling reflection.

Several techniques have been found useful in maintaining an adequate quantity of light while limiting loss of contrast. These include the following:

Observers, tasks, and light sources should be positioned to reduce reflected glare. If there is only a single light source, positional change should remove it from the field of vision. When daylighting is used, occupants should be faced parallel to or away from windows, rather than toward them. When overhead luminaires are used, they should be positioned on either side of and behind the occupants, instead of in the general area above and forward of them. When continuous rows of linear luminaires are used, the occupants should be positioned between the rows with the line of sight parallel to the longitudinal axes of the luminaires.

TABLE 15.4 Recommended Maximum Luminances of Light Sources

Angle with vertical, degrees	Luminance, fL
45	2250
55	1605
65	1125
75	750
85	495

Increase in luminance of the task will offset the loss of contrast, if the added illumination is provided at nonglare angles.

Decrease in the overall brightness of light sources or the brightness at angles that cause glare also is helpful. When windows are the sources of glare, it can be reduced or eliminated by tilting blinds. When luminaires are used, brightness of the source should be kept low to minimize glare. Low-brightness sources with large areas usually cause less glare than small sources with high luminance. As an alternative, the whole ceiling can be used as an indirect light source, which reflects light directed onto it by luminaires. These fixtures should be suspended at least 18 in below the ceiling to prevent high-brightness spots from being created on it. The ceiling should be white and clean and have a matte finish to diffuse the light.

Reflected glare also can be reduced by use of luminaires that distribute light mostly at nonoffending angles. Tasks are usually observed in a downward direction at angles with the vertical of 20 to 40°. Consequently, light incident on the task at those angles may cause reflected glare. Therefore, selection of a luminaire that produces little or no light at angles less than 40° cannot cause glare. Figure 15.12*a* illustrates the candlepower distribution curve for a luminaire that directs little light downward. (Note that it also directs little light near the horizontal, to prevent direct glare.) The curve is called a batwing, because of its shape. As indicated in Fig. 15.12*b*, a high percentage of the light from this luminaire cannot produce veiling reflections.

Specularity of the task can be a major cause of reflected glare. Consequently, high-gloss surfaces in the field of vision should be avoided. Often, tilting the task can reduce or eliminate veiling reflections.

Use of low-level illumination throughout a space, supplemented by local lighting on the task, offers several advantages, including adequate light with little or no glare and flexibility in positioning the local light source.

In many work environments, observers find themselves confronted with reflected glare both on horizontal surfaces, when reading material on a desktop, and on approximately vertical surfaces, when viewing a *visual display terminal* (VDT) screen. Designers should be aware of this and should be certain that the lighting system used to alleviate veiling reflections on horizontal materials does not aggravate the problem on the VDT screen. Luminaires selected to direct light outward

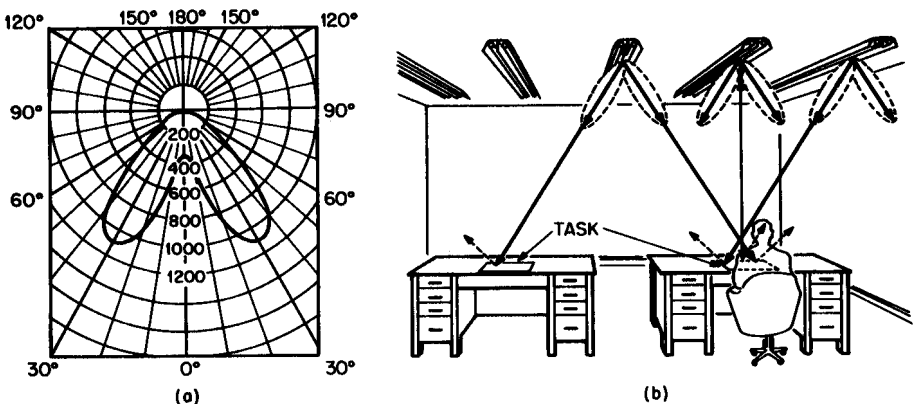

FIGURE 15.12 Example of control of light distribution to reduce veiling reflections: (a) batwing candlepower distribution curve for a luminaire; (b) arrangement of fluorescent lighting fixtures with distribution shown in (a), task and observer to limit veiling reflections.

beyond 40° from vertical to avoid veiling reflections may produce direct glare on the VDT. In general, in design of lighting systems for areas with VDTs, illuminance levels should be kept low, less than 75 fc. Illuminance ratios in the area also should be kept low, fixtures that have high VCPs should be selected and surface finishes that might reflect onto the VDT screen should have medium to low reflectances.

Luminaires with parabolic louvers, either small-cell, intermediate-cell, or deep-cell, are often used. They provide good illuminance on horizontal surfaces while contributing almost no direct glare onto the screen. They do, however, create a visual environment with relatively dark ceiling space that some may find objectionable.

Pendant-mounted, indirect-lighting luminaires or direct-indirect fixtures using fluorescent or HID sources can also be successfully applied to areas with VDTs. They produce a brighter feeling in the space for the occupants. Care must be taken to select luminaires with properly designed light control and to mount them sufficiently below the ceiling to create a uniform brightness across the ceiling surface. Failure to meet these requirements can result in “hot spots” on the ceiling that will be reflected onto the VDT screen. A relatively uniform, though somewhat bright, ceiling luminance reflected onto the screen is not objectionable to the viewer (VDT contrast and brightness controls can be adjusted to compensate) but the hot spots on the screen force the viewer’s eyes to be constantly adjusting to the differences in reflected glare, causing eye fatigue and discomfort. (See “The IES Recommended Practice for Lighting Offices Containing Computer Visual Display Terminals (VDT’s) RP-24,” Illuminating Engineering Society of North America.)

See Art. 15.20, Bibliography.

15.12 COLOR RENDERING WITH LIGHTING

A black body is colorless. When increasing heat is applied to such a body, it eventually develops a deep red glow, then cherry red, next orange, and finally blue-white. The color of the radiated light is thus related to the temperature of the heated body. This phenomenon is the basis for a temperature scale used for the comparison of the color of light from different sources. For example, the light from an incandescent lamp, which tends to be yellowish, may be designated 2500 Kelvin (K), whereas a cool white fluorescent lamp may be designated 4500 K.

Light used for general illumination is mainly white, but white light is a combination of colors and some colors are more predominant than others in light emitted from light sources commonly used. When light other than white is desired, it may be obtained by selection of a light source rich in the desired hue or through use of a filter that produces that hue by absorbing other colors.

Color rendering is the degree to which a light source affects the apparent color of objects. **Color rendering index** is a measure of this degree relative to the perceived color of the same objects when illuminated by a reference source for specified conditions. The index actually is a measure of how closely light approximates daylight of the same color temperature. The higher the index, the better is the color rendering. The index for commonly used light sources ranges from about 20 to 99.

Generally, the color rendering of light should be selected to enhance color identification of an object or surface. This is especially important in cases where color coding is used for safety purposes or to facilitate execution of a task. Color enhancement is also important for stimulating human responses; for example in a

restaurant, warm-colored light would make food served appear more appetizing, whereas cool-colored light would have the opposite effect.

Sources producing white light are generally used. Because of the spectral energy distribution of the light, however, some colors predominate in the illumination. For example, for daylight, north light is bluish, whereas direct sunlight at midday is yellow-white; and light from an incandescent lamp is high in red, orange, and yellow. The color composition of the light may be correlated with a color temperature. For a specific purpose, a source with the appropriate color characteristics should be chosen. Lamp manufacturers provide information on the color temperature and color rendering index of their products.

Colored light, produced by colored light sources or by filtering of white light, is sometimes used for decorative purposes. Colored light also may be used to affect human moods or for other psychological purposes, as indicated in Art. 15.10.8. Care must be taken in such applications to avoid objectionable reactions to the colored light; for example, when it causes unpleasant changes in the appearance of human skin or other familiar objects.

Perceived color of objects also is affected by the level of illumination (Art. 15.10.8). When brilliant color rendition is desired and high-intensity lighting is to be used, the color saturation of the objects should be high; that is, colors should be vivid. Also, a source that would enhance the colors of the objects should be chosen.

See Art. 15.20, Bibliography.

15.13 QUANTITY OF LIGHT

As indicated in Art. 15.11, quantity and quality of light are actually inseparable in contributing to good lighting, although they are treated separately, for convenience of presentation, in this section. Illumination should meet the requirements of visual tasks for safe, efficient performance, esthetic reasons, and the purpose of attracting attention. Factors that affect visual performance of a task include:

- Luminance, or brightness, of the task
- Luminance relation between task and surroundings
- Color rendering of the light
- Size of details to be detected
- Contrast of the details with their background
- Duration and frequency of occurrence of the task
- Speed and accuracy required in performance of the task
- Age of workers

The influence of these factors on visibility is described in Art. 15.10.

Dim lighting is sometimes desirable for mood effects. For merchandising, however, a pattern of brightness is depended on to capture the attention of potential customers. For task lighting, sufficient lighting must be provided on the work area if the task is to be executed without eyestrain and fatigue. Higher than the minimum required level of illumination usually improves visibility but often with greater energy consumption and increased life-cycle costs for both lighting and cooling the

TABLE 15.5 Weighting Factors for Determining Visual Conditions*

Task and worker characteristics	Weight <i>W</i>
Workers' ages	
Under 40	-1
40 to 55	0
Over 55	+1
Importance of speed or accuracy†	
Not important	-1
Important (errors costly)	0
Critical (errors unsafe)	+1
Reflectance of task background	
Greater than 70%	-1
30 to 70%	0
Less than 30%	+1

*Based on data in "Selection of Illuminance Values for Interior Lighting Design," RP-15A, Illuminating Engineering Society of North America. Calculate ΣW by adding the weighting factors *W* for the specific environment or required performance and determine the corresponding visual condition from Table 15.7.

†Use *W* = 0 for environment categories A to C.

TABLE 15.6 Visual Condition Number for Determining Recommended Illuminances

Category	ΣW^*						
	3	2	1	0	-1	-2	-3
A to C		4	4	3	2	2	
D to I	4	4	3	3	3	2	2

* ΣW = sum of weighting factors given in Table 15.5 for a specific environment or required performance.

building. Consequently, for task lighting, illumination should be kept to the minimum necessary for maintenance of adequate quantity and quality of lighting.

For many years, single values for minimum illuminance, or level of illumination, *f_c*, developed by the Illuminating Engineering Society of North America (IES) and listed in tables in the "IES Lighting Handbook," have been widely used in the United States. In 1979, however, the IES revised its criteria to a recommended range of target illuminances. These recommended values take into account many of the factors listed above. Following is an example and abbreviated tables to illustrate the use of the tables in the IES handbook.

To determine the target illuminance, start by ascertaining the type of activity, or illuminance category, for the space to be illuminated. (The "IES Lighting Handbook" contains a detailed table correlating specific areas or activities with categories labeled A to I. For some of these categories, the effects of veiling reflections should be evaluated, for which purpose equivalent-sphere-illumination, ESI, calculations may be used, as indicated in Art. 15.10.5.) The first column of Table 15.7, which

TABLE 15.7 Recommended Illuminances for Interior Lighting, fc^a

Category of environment or required performance	Visual condition ^b			
	1. Short exposure	2. Moderate	3. Ordinary	4. Severe
A. Public areas with dark surroundings ^d		2	3	5
B. Simple orientation for short visits ^d		5	7.5	10
C. Working spaces for infrequent tasks ^d		10	15	20
D. Tasks with high contrast or large size ^{e,f}		20	30	50
E. Tasks with medium contrast or small size ^{e,g}	30	50	75	100
F. Tasks with low contrast or very small size ^{e,h}	75	100	150	200
G. Tasks with low contrast, very small size, and long duration ^{i,j}		200	300	500
H. Very prolonged and exacting tasks ^{i,k}		500	750	1000
I. Tasks with extremely low contrast and small size ^{i,l}		1000	1500	2000

^aBased on data in "Selection of Illuminance Values for Interior Lighting Design," RP-15A, Illuminating Engineering Society of North America.

^bVisual condition depends on workers' ages, importance of speed and accuracy in performance of task, and reflectance of task background. For tasks that occur infrequently or are of short duration and if conditions 2, 3, or 4 would be applicable, use conditions 1, 2, or 3, respectively. Where no value is given for condition 1, use condition 2. See text and Tables 15.5 and 15.6.

^cBased on British IES "Code for Interior Lighting," 1977.

^dGeneral lighting throughout the building space.

^eIlluminance on task.

^fFor example, reading printed material, typed originals, handwriting in ink or good xerography; rough bench or machine work; ordinary inspection; or rough assembly.

^gFor example, reading medium pencil handwriting, poorly printed or reproduced material; medium bench or machine work; difficult inspection, or medium assembly.

^hFor example, reading handwriting in hard pencil on poor-quality paper or very poor reproductions, or highly difficult inspections.

ⁱIlluminance on task, obtained by combining general and local (supplementary) lighting.

^jFor example, fine assembly, unusually difficult inspection, or fine bench or machine work.

^kFor example, the most difficult inspection, extra-fine bench or machine work, or extra-fine assembly.

^lFor example, surgical procedures.

is based on descriptions in "Selection of Illuminance Values for Interior Lighting Design," IES RP-15A, gives a general description of these categories.

Next, determine the appropriate weighting factors W from Table 15.5 to adjust for loss of visual acuity with age, for importance of speed and accuracy in performing tasks, and for reflections of task background. For categories A to C, for which there are no task activities, use $W = 0$ as the weight for speed and accuracy. Then, add the weighting factors. From Table 15.6, determine the visual condition number corresponding to ΣW and the category. Decrease the condition number by one if the task is of short duration or occurs infrequently. Finally, select the target illuminance, fc , from Table 15.7 corresponding to the category and visual condition.

The IES recommends that if information is available on the effect of changes in illuminance or equivalent sphere illumination, ESI, on task performance, the data

may be used to determine if a variation from the design illuminance or ESI will be meaningful in terms of increased or decreased productivity, which may be used in a cost-benefit analysis.

See Art. 15.20, Bibliography.

15.14 LIGHTING METHODS

Interior lighting may be accomplished with natural or artificial illumination, or both. Natural illumination is provided by daylight. Artificial illumination usually is produced by consumption of electric power in various types of lamps and sometimes by burning candles or oil or gas in lamps. Usually, electric lighting for building spaces is produced by lighting devices called **luminaires**, which consist of one or more lamps, a fixture in which the lamps are held, lenses for distributing the light, and parts for supplying electricity. Fixtures may be portable or permanently set in or on ceilings or walls.

To meet specific lighting objectives, the following lighting methods may be used alone or in combination:

General Lighting. This provides uniform and, often, diffuse illumination throughout a space. This type of lighting is useful for performing ordinary activities and for reducing the relative luminance of surroundings when local lighting is applied to a work area.

Local or Functional Lighting. This provides a high level of illumination on the relatively small area in which a task is to be performed, such as reading, writing, or operation of tools.

Accent Lighting. This actually is a form of local lighting, but it has the objective of creating focal points for observers, to emphasize objects on display.

Decorative Lighting. This employs color or patterns of light and shadow to attract attention, hold interest, produce visual excitement or a restful atmosphere, or create esthetic effects.

Illumination may be classified as indirect, semiindirect, diffuse or direct-indirect, semidirect, or direct.

For indirect lighting, about 90 to 100% of the illumination provided in a space is directed at the ceiling and upper walls, and nearly all of the light reaches the task by reflection from them. The resulting illumination is, therefore, diffuse and uniform, with little or no glare.

For semiindirect lighting, about 60 to 90% of the illumination is directed at the ceiling and upper walls, the remaining percentage in generally downward directions. When overhead luminaires are used, the downward components should be dispersed by passage through a diffusing or diffracting lens to reduce direct glare. The resultant illumination on a task is diffuse and nearly glarefree.

General diffuse or direct-indirect lighting is designed to provide nearly equal distribution of light upward and downward. General-diffuse luminaires enclose the light source in a translucent material to diffuse the light and produce light in all directions. Direct-indirect luminaires give little light near the horizontal. Quality of

the resulting illumination from either type depends on the type of task and the layout of the luminaires.

For semidirect lighting, about 60 to 90% of the illumination is directed downward, the remaining percentage upward. Depending on the eye adaptation level, as determined by overall room luminance, the upward component may reduce glare. Diffuseness of the lighting depends on reflectance of room enclosures and furnishings.

For direct lighting, almost all the illumination is directed downward. If such luminaires are spread out, reflections from room enclosures and furnishings may diffuse the light sufficiently that it can be used for general lighting, for example, in large offices. A concentrated layout of these luminaires is suitable for accent, decorative, or local lighting. Because direct lighting provides little illumination on vertical surfaces, provision of supplementary perimeter lighting often is desirable.

Lighting Distribution. Luminaires are designed for a specific type of lamp to distribute light in a way that will meet design objectives. For this purpose, luminaires incorporate various shapes of reflectors and various types of lenses (Fig. 15.13). Also, size and shape of openings through which light is emitted is controlled.

A luminaire may provide symmetrically or asymmetrically distributed light. With symmetrical distribution (Fig. 15.11), the level of illumination, f_c , on a work plane is nearly the same at the same angle with the vertical and at equal distances from the light source. With asymmetrical distribution (Fig. 15.13c), the luminaire concentrates light in a specific direction. Symmetrical distribution is appropriate for general lighting. Asymmetrical distribution is advantageous for accent lighting.

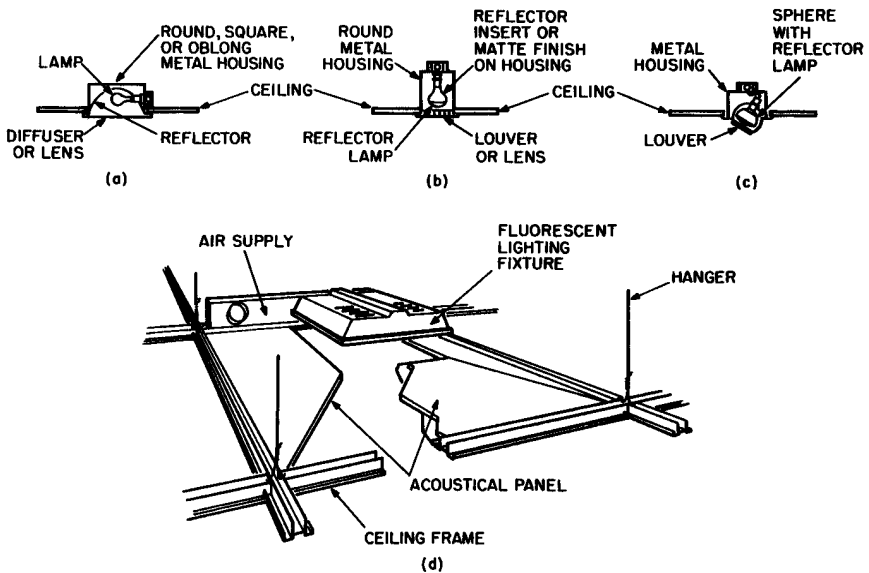

FIGURE 15.13 Examples of recessed fixtures: (a) for direct widespread lighting; (b) for direct, narrow-beam lighting; (c) for asymmetrical direct lighting; (d) for direct diffuse lighting.

See Art. 15.20, Bibliography.

15.15 DAYLIGHT

Use of natural light has the advantages, compared with artificial illumination, of not consuming fuel and not having associated operating costs. But daylight has the disadvantages of being dependent on the availability of windows and on the absence of light-blocking obstructions outside the windows, of not being available between sunset and sunrise, and of providing weak light on cloudy days and around twilight and dawn. When lighting is needed within a building at those times, it must be provided by artificial illumination. Also, for parts of rooms at large distances from windows, where adequate daylight does not reach, artificial illumination is needed to supplement the daylight. When supplementary lighting is required, initial, maintenance, and replacement costs of lamps and fixtures are not saved by use of daylight, although costs of power for lighting can be reduced by turning off lamps not needed when daylight is available. In addition, design for daylighting should be carefully executed so as not to introduce undesirable effects, for example, glare, intensive sunlight, or excessive heat gain.

Elements can be incorporated in building construction to control daylight to some extent to provide good lighting within short distances from windows. For example, to prevent glare, windows may be shielded, by blinds or by outside overhangs, against direct sunlight. To reduce heat gain, windows may be glazed with reflecting, insulating, or heat-absorbing panes. Ceiling, floor, and walls with high reflectance should be used to diffuse light and reflect it into all parts of rooms. To illuminate large rooms, daylight should be admitted through more than one wall and through skylights or other roof openings, if possible. In rooms that extend a long distance from windows, the tops of the windows should be placed as close to the ceiling as possible, to permit daylight to penetrate to the far end of the room.

Design procedures for daylighting are presented in "Recommended Practice for Daylighting," RP-5, Illuminating Engineering Society of North America.

15.16 CHARACTERISTICS OF LAMPS

Selection of the most suitable lamp consistent with design objectives is critical to performance and cost of a lighting system. This decision should be carefully made before a luminaire for the lamp is selected. Luminaires are designed for specific lamps.

Lamps are constructed to operate at a specific voltage and wattage, or power consumption. In general, the higher the wattage rating of a specific type of lamp, the greater will be its **efficacy**, or lumen output per watt.

15.16.1 Considerations in Lamp Selection

Greatest economy will be secured for a lighting installation through use of a lamp with the highest lumen output per watt with good quality of illumination. In addition to lumen output, however, color rendering and other characteristics, such as lighting distribution, should also be considered in lamp selection. Information on these char-

acteristics can be obtained from lamp manufacturers. Latest data should be requested, because characteristics affecting lamp performance are changed periodically. The following information usually is useful:

Lamp life, given as the probable number of hours of operation before failure.

Lamp efficacy, measured by the lamp output in lumens per watt of power consumed.

Lamp lumen depreciation, as indicated by tests. Curves are plotted from data to show the gradual decrease in light output with length of time of lamp operation. The decrease occurs because of both aging and dirt accumulation (Art. 15.16.2). The latter can be corrected with good maintenance, but the possible effects nevertheless should be considered in lighting design.

Lamp warm-up time, which is significant for some fluorescent lamps and all high-intensity-discharge lamps, for which there is a delay before full light output develops.

Lamp restart time, or time that it takes some lamps to relight after they have been extinguished momentarily. The lamps may go out because of low voltage or power interruption. Use of lamps with long warm-up and restart times should be avoided for spaces where lights are to be turned on and off frequently.

Color rendering index and color acceptability, which are, respectively, measures of the degree to which illumination affects the perceived color of objects and the human reaction to perceived colors (see Art. 15.12).

Voltages and frequency of current at which lamps are designed to operate. In most buildings in the United States, electricity is distributed for light and power as an alternating current at 60 Hz. Lamp output generally increases at higher frequencies but capital investment for the purpose is higher. Voltage often is about 120, but sometimes, especially for industrial and large commercial buildings, voltages of 208, 240, 277, or 480 are used, because of lower transmission losses and more efficient operation of electrical equipment. Direct current from batteries often is used for emergency lighting, when the prime ac source fails. Low-voltage (generally 12-V) lamps may be used outdoors, for safety reasons, when conductors are placed underground or where the lamps are immersed in water.

Noise, which is significant for some types of lamp applications, such as fluorescent and high-intensity-discharge lamps. These depend for operation on a device, called a ballast, which may hum when the light operates. Whether the hum will be annoying under ordinary circumstances depends on the ambient noise level in the room. If the ambient level is high enough, it will mask the hum. Before a combination of lamp, ballast, and fixture is selected, ballast noise rating should be obtained from the luminaire manufacturer.

Ambient temperature, or temperature around a lamp when it is operating, which may affect lamp life, lumen output, and color rendering. If the ambient temperature exceeds the rated maximum temperature for the luminaire, the life of incandescent lamps may be considerably reduced. Consequently, lamps rated at a wattage greater than that recommended by the fixture manufacturer should not be used. Also, provision should be made for dissipation of the heat produced by lamps. Low ambient temperature slows starting of fluorescent and high-intensity-discharge lamps. Low temperature also reduces lumen output and changes the color of fluorescent lamps.

15.16.2 Maintenance of Lamp Output

The efficiency of a lighting system decreases with time because of dirt accumulation, decrease in lumen output as lamps age, lamp failures, and deteriorating lighting

fixtures. Depending on type of fixtures, cleanliness of the environment, and time between cleanings of lamps and fixtures, lumen losses due to dirt may range from 8 to 10% in a clean environment to more than 50% under severe conditions. Also, the longer lamps operate, the dimmer they become; for example, a fluorescent lamp at the end of its life will yield only 80 to 85% of its initial lumen output. And when one or more lamps fail and are not replaced, the space being illuminated may suffer a substantial loss in light. Furthermore, in the case of lights operating with ballasts, the lamps, before burning out, overload the ballast and may cause it to fail. Consequently, a poorly maintained lighting installation does not provide the illumination for which it was designed and wastes money on the power consumed.

The design illumination level may be maintained by periodic cleaning and prompt replacement of aged or failed lamps. Relamping may be carried out by the spot or group methods. Spot relamping, or replacement of lamps one by one as they burn out, is more inefficient in use of labor and more costly. Group relamping calls for scheduled replacement of lamps at intervals determined from calculations based on expected lamp life and variation of lumen output with time. This method reduces labor costs, causes fewer work interruptions, maintains higher levels of illumination with no increase in cost of power, prevents the appearance of the lighting system from deteriorating, and reduces the possibility of damage to auxiliary equipment, such as ballasts, near the end of lamp life.

Because of the decrease in lamp output with time, in design calculations initial lamp output should be multiplied by a lamp lumen depreciation factor to correct for the effects of aging. This product equals the output after a period of time, usually the interval between group relampings. In addition, the output should be multiplied by a dirt depreciation factor. Both factors are less than unity. The two factors may be combined into a single maintenance factor M .

$$M = \text{LLD} \times \text{LDD} \quad (15.33)$$

where LLD = lamp lumen depreciation factor
LDD = dirt depreciation factor

After a period of operation, lamp output then is given by

$$L = L_i M \quad (15.34)$$

where L_i = initial output, lm

15.16.3 Lamp Control

Incoming power for a lamp normally is by a local switch in the power circuit. The switch turns the lamps on or off by closing or opening the circuit.

An alternative method may be used that is more economical when the lamps are distant from the switch and that reduces the possibility of personal injury or short-circuit damage at the switch. In this method, the main power circuit is opened and closed by a relay located near the lamps. The relay, in turn, may be activated by low-voltage power controlled by a remote switch. Control-system voltages usually range between 6 and 24 V, obtained by stepping down the normal distribution voltage with transformers.

To prevent waste of energy by lighting in unoccupied rooms, occupancy sensors may be installed. They sense entry of a person into a room and turn lights on. They also detect continued presence in the room and keep the lights on until after departure.

For control of light output from a luminaire, a control switch may be replaced with a dimmer. For incandescent lamps, this device can vary the voltage across the lamps from zero to the rated value and thus can be used to adjust the level of illumination. For fluorescent and high-intensity-discharge lamps, the dimmer is coordinated with the lamp ballast.

15.16.4 Types of Lamps

Lamps that are commonly used may be generally classified as incandescent, fluorescent, or high-intensity-discharge (HID). HID lamps include mercury-vapor, metal-halide, low-pressure sodium, and high-pressure sodium lamps. See Tables 15.8 and 15.9.

Incandescent Lamps. These lamps generate light by heating thin tungsten wires until they glow. The filaments are enclosed in a sealed glass bulb from which air is evacuated or that is filled with an inert gas, to prevent the heated tungsten from evaporating. In a tungsten-halogen incandescent lamp, for prolonged life, the filler gas contains halogens (iodine, chlorine, fluorine, and bromine), which restores to the filaments any metal that may evaporate.

Incandescent lamps are available in a variety of shapes. They also come with a variety of bases, making it necessary to ensure that selected luminaires provide sockets that can accommodate the desired lamps.

Incandescent lamps produce light mainly in the yellow to red portion of the spectrum. Color depends on the wattage at which the lamp is operated. Generally, the higher the wattage, the whiter is the color of light produced. A reduction in wattage or voltage results in a yellower light. See Tables 15.8 and 15.9 for other characteristics of incandescent lamps.

Often, the glass bulbs of these lamps are treated to obtain special effects. Usually, the effect desired is diffusion of the emitted light, to soften glare. For the purpose, the glass may be frosted, or etched, or silica coated (white bulb). Light diffusion and other effects can also be achieved with control devices incorporated in the fixtures, such as lenses or louvers (Figs. 15.13 to 15.16). Also, lamps may be treated with coatings or filters to produce any of a variety of colors.

Reflectorized incandescent lamps are made, with standard or special shapes, with a reflective aluminized or silver coating applied directly to part of the inside bulb surface. Such lamps are widely used for spot or flood lighting. Type PAR lamp has a parabolic shape to focus the light beam. Types EAR and ER lamps have elliptical shapes that cause the light beam to concentrate near the front of the lens, then to broaden into the desired pattern, yielding more usable light than other types of lamps, with little glare.

Compact fluorescent lamps often can be used, to reduce energy consumption significantly, in applications where incandescent lamps were used in the past.

Fluorescent Lamps. These lamps are sealed glass tubes coated on the inside surface with phosphors, chemicals that glow when bombarded by ultraviolet light. The tubes are filled with an inert gas, such as argon, and low-pressure mercury vapor. Passage of an electric arc through the mercury vapor causes it to emit the ultraviolet rays that activate the phosphors to radiate visible light. The electric arc is started and maintained by cathodes at the ends of the glass tubes.

The high voltage needed to form the arc is provided initially by a device called a **ballast**. After the arc has been formed, the ballast limits the current in the arc to that needed to maintain it. Ballasts also may be designed to decrease the strobo-

TABLE 15.8 Characteristics of Lamps Often Used for General Lighting

Lamp characteristic	Type of lamp						
	Incandescent	Tungsten-halogen incandescent	Fluorescent	Clear mercury	Clear metal halide	Clear high-pressure sodium	Clear low-pressure sodium
Efficacy, lm/W	15–25	6–23	25–84	30–63	68–125	77–140	137–183
Initial lumens	40–33,600	40–33,600	96–15,000	1,200–63,000	12,000–155,000	5,400–140,000	4,800–33,000
Lumen maintenance, %	80–90	75–97	75–91	70–86	73–83	90–92	75–90
Wattage range	5–1,500	6–1,500	4–215	40–1,000	175–1,500	70–1,000	35–180
Life, hr	750–1,000	750–8,000	9,000–20,000	16,000–24,000	1,500–15,000	20,000–24,000	18,000
Color temperature, K	2,400–3,400	2,800–3,400	2,700–6,500	3,300–5,900	3,200–4,700	2,100	1,780
Color rendering index	89–92	95–99	55–95	22–52	65–70	21	0
Color acceptability	Good	Good	Good	Fair	Good	Fair	Poor
Light control	Excellent	Excellent	Poor	Fair	Fair to good	Good	Poor
Initial cost per lamp	Low	Low	Moderate	Moderate	High	High	Moderate
Energy cost	High	High	Moderate	Moderate	Low	Low	Low

Courtesy of Sylvania Lighting.

TABLE 15.9 Comparison of Lamps Often Used for General Lighting*

Type of lamp	Lamp characteristics																									
	Color rendering		Initial efficacy, lm/W	Lumen maintenance (mean lm)	Rated average life, hr	Degree of light control	Input power required for equal light	System operating cost for equal light	Initial equipment cost for equal light	Total owning and operating cost	Relative rating of lamps															
	Very important	Important	Unimportant	Highest (80 up)	Medium (50-80)	Lowest (15-50)	Highest (85% up)	Medium (75-85%)	Fair (65-75%)	Shortest (5,000 or less)	Intermediate (5,000-15,000)	Longest (15,000-25,000)	Highest	Intermediate	Lowest	Highest	High	Intermediate	Lowest	Highest	Intermediate	Lowest	Highest	Intermediate	Lowest	
Incandescent	•					•	•		•				•		•					•			•	•		
Tungsten-halogen	•					•	•		•				•		•					•			•	•		
Fluorescent	•				•							•		•							•				•	
Clear mercury			•		•						•	•			•					•			•		•	
Coated mercury		•			•						•		•							•			•		•	
Clear metal halide	•									•			•							•			•		•	
Coated metal halide	•								•		•									•			•		•	
Clear high-pressure sodium			•	•							•	•								•			•	•		•
Coated high-pressure sodium			•	•							•		•							•			•	•		•

*Dot indicated that the light source exhibits the listed characteristics.
Courtesy of Sylvania Lighting.

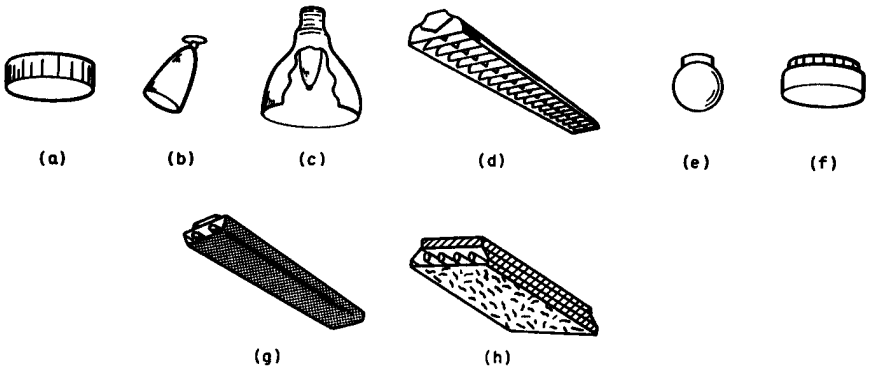

FIGURE 15.14 Examples of ceiling-mounted fixtures: (a) opaque-side drum for direct diffuse lighting; (b) spotlighting with incandescent lamp; (c) direct, widespread lighting with an HID lamp; (d) fluorescent fixture for direct diffuse lighting; (e) globe fixture with incandescent lamp for direct diffuse lighting; (f) small diffusing drum; (g) fluorescent fixture for semidirect diffuse lighting; (h) fluorescent fixture with diffusing lens for direct lighting.

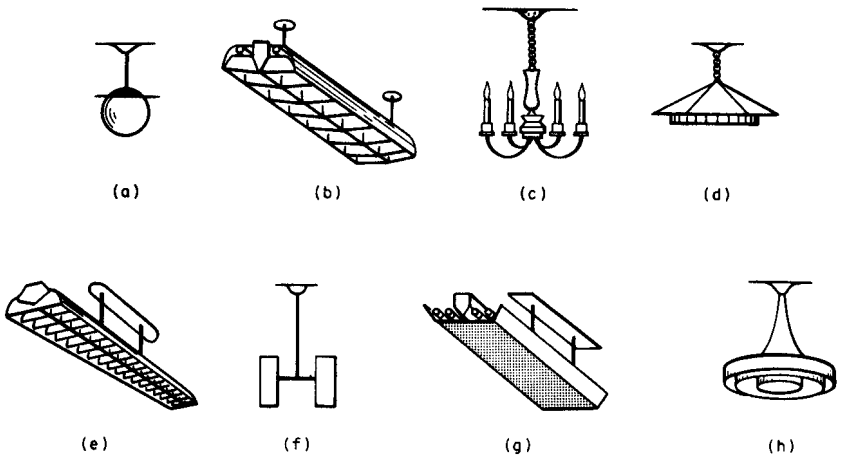

FIGURE 15.15 Examples of pendant fixtures: (a) globe fixture for direct diffuse light; (b) fluorescent fixture for general diffuse lighting; (c) exposed-lamp fixture for direct lighting; (d) direct downlight fixture; (e) fluorescent fixture for semidirect lighting; (f) fixture for direct-indirect lighting; (g) fluorescent fixture for semiindirect lighting; (h) fixture with high-intensity discharge (HID) lamp for indirect lighting.

scopic effect of the lamp output caused by the ac power supply and to keep the variation in current nearly in phase with the variation in voltage, thus maintaining a high power factor.

Fluorescent lamps generally are available as linear, bent U, compact configuration, or circular tubes, and luminaires are designed to be compatible with the selected shape.

Fluorescent lamps may be classified as preheat, rapid start, or instant start. They differ in the method used to decrease the delay in starting after a switch has been

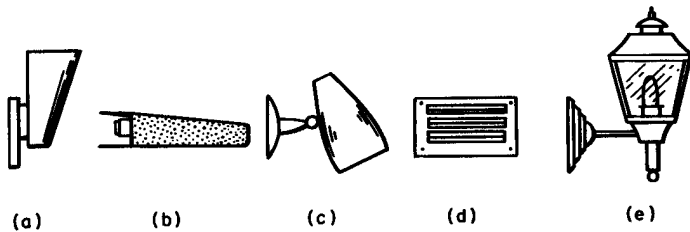

FIGURE 15.16 Examples of wall-mounted fixtures: (a) small diffuser type; (b) linear type, for example, four-lamp incandescent or a fluorescent lamp; (c) bullet-type, directional fixture, for accent lighting; (d) fixture for directional night lighting; (e) exposed-lamp fixture for direct lighting.

thrown to close the electrical circuit. The preheat type requires a separate starter, which allows current to flow for several seconds through the cathodes, to preheat them. For a rapid-start lamp, the cathodes are electrically preheated much more rapidly without a starter. For an instant-start lamp, high voltage from a transformer forms the arc, without the necessity of preheating the cathodes.

Instant-start lamps may be of the hot-cathode or cold-cathode type, depending on cathode shape and voltage used. Efficacy of cold-cathode lamps is lower than that of hot-cathode lamps. Both types are more expensive than rapid-start lamps and are less efficient in lumen output. Instant-start lamps, however, come in sizes that are not available for rapid-start lamps and can operate at currents that are not feasible for rapid-start lamps. Also, instant-start lamps can start at lower temperatures, for instance, below 50°F.

The life of most types of fluorescent lamps is adversely affected by the number of lamp starts. Cold-cathode lamps, however, have a long life, which is not greatly affected by the number of starts.

Fluorescent lamps last longer and have a higher efficacy than incandescent lamps. (See Tables 15.8 and 15.9.) Hence, fluorescent lamps cost less to operate. Initial cost of fixtures, however, may be higher. Fluorescent lamps require larger fixtures, because of tube length, and special equipment, such as ballasts and transformers (Figs. 15.13 to 15.16). Also associated with such lamps is ballast hum and possible interference with radio reception. Pattern control of light is better with incandescent lamps, but lamp brightness is low with fluorescent lamps, so that there is less likelihood of glare, even when the lamps are not shielded.

Color rendering of light emitted by a fluorescent lamp depends on the phosphors used in the tube. The best color rendering for general use may be obtained with the deluxe cool white (CWX) type. Check with manufacturers for color characteristics of lamps currently available, because new lamps designed with color rendering appropriate for specific purposes are periodically introduced.

High-Intensity-Discharge (HID) Lamps. These lamps generate light by passage of an electric arc through a metallic vapor, which is contained in a sealed glass or ceramic tube. The lamps operate at pressures and electrical current densities sufficient to produce desired quantities of light within the arc. Three types of HID lamps are generally available: mercury vapor, metal-halide, and high-pressure sodium. Major differences between them include the material and type of construction used for the tube and the type of metallic vapor. In performance, the lamps differ in efficacy, starting characteristics, color rendering, lumen depreciation, price, and life. (See Tables 15.8 and 15.9.) HID lamps are available with lumen outputs consid-

erably greater than those of the highest-wattage fluorescent lamps available. HID lamps require ballasts that function like those for fluorescent lamps and that should be coordinated with the type and size of lamp for proper operation.

Each time an HID lamp is energized from a cold start, the lamp produces a dim glow initially and there is a time interval called *warm-up time* until the lamp attains its full lumen output. Warm-up time for metal-halide and sodium vapor lamps may range from 3 to 5 mm and for mercury vapor lamps from 5 to 7 mm. When the power to the lamp is interrupted, even momentarily, the lamp extinguishes immediately; and even if the power is restored within a short time, while the lamp is still hot, there is a delay, until the lamp cools to provide a condition that will permit the arc to restrike. Sodium vapor lamps have the fastest restart time, 1 mm, compared with 3 to 6 mm for mercury vapor lamps and as much as 10 mm for metal-halide lamps. Because of this condition, it is desirable to employ supplemental lighting to provide minimal illumination during these intervals. (Lamp-ballast combinations that provide instant restart are available for metal-halide lamps. Though expensive, they have applications in security and sports lighting.)

The color of clear mercury lamps tends to be bluish. This type of lamp, however, also is available coated with phosphors that improve color rendering. The color of clear metal-halide lamps is stark white, with subtle tints ranging from pink to green. These lamps also may be coated for color correction. Light from clear sodium lamps, however, is yellowish. It strengthens yellow, green, and orange, but grays red and blue and turns white skin complexions yellow. Sodium lamps also may be coated to improve color rendering, but as color rendering is improved, efficacy decreases somewhat. Light from low-pressure clear sodium lamps is almost pure yellow. Use of such lamps, as a result, is limited to applications where color rendering is unimportant, such as freight yards and security lighting.

With respect to annual cost of light, high-pressure sodium lamps with ceramic (aluminum-oxide) arc tubes, with relatively small size, high efficacy, long life, and excellent lumen maintenance, appear to be the most economical HID type. Some variations of this type of lamp also offer improved color rendering.

HID lamps require special luminaires and auxiliaries. Some of these fixtures will accept replacement HID lamps of any of the three types in specific wattages. Others will accept only one type.

See Art. 15.20, Bibliography.

15.17 CHARACTERISTICS OF LIGHTING FIXTURES

A lighting fixture is that component of a luminaire that holds the lamps, serves as a protective enclosure, or housing, delivers electric power to the lamps, and incorporates devices for control of emitted light. The housing contains lampholders and usually also reflective inside surfaces shaped to direct light out of the fixture in controlled patterns. In addition, a fixture also incorporates means of venting heated air and houses additional light-control equipment, such as diffusers, refractors, shielding, and baffles. The power component consists of wiring and auxiliary equipment, as needed, such as starters, ballasts, transformers, and capacitors. The light-control devices include louvers, lenses, and diffusers. Fixture manufacturers provide information on construction, photometric performance, electrical and acoustical characteristics, installation, and maintenance of their products.

Some luminaires are sealed to keep out dust. Some are filtered and vented to dissipate heat and prevent accumulation of dust. Also, some are designed as part of the building air-conditioning system, which removes heat from the lamps before it enters occupied spaces. In some cases, this heat is used to warm spaces in the building that require heating.

Safety Requirements. Construction and wiring of fixtures should conform with local building codes and the National Electrical Code (NEC), recommendations of the National Electrical Manufacturers Association (NEMA) and “Standard for Lighting Fixtures,” Underwriters Laboratories, Inc.

The NEC requires that fixtures to be installed in damp or wet locations or in hazardous areas containing explosive liquids, vapors, or dusts be approved by Underwriters Laboratories for the specific application. Auxiliary equipment for fluorescent and HID lamps should be enclosed in incombustible cases and treated as sources of heat.

The NEC specifies that fixtures that weigh more than 6 lb or are larger than 16 in in any dimension not be supported by the screw shell of a lampholder. The code permits fixtures weighing 50 lb or less to be supported by an outlet box or fitting capable of carrying the load. Fixtures also may be supported by a framing member of a suspended ceiling if that member is securely attached directly to structural members at appropriately safe intervals or indirectly via other adequately supported ceiling framing members. Pendant fixtures should be supported independently of conductors attached to the lampholders.

The NEC also requires that fixtures set flush with or recessed in ceilings or walls be so constructed and installed that adjacent combustible material will not be exposed to temperatures exceeding 90°C. (Thermal insulation should not be installed within 3 in of a recessed fixture.) Fire-resistant construction, however, may be exposed to temperatures as high as 150°C if the fixture is approved for such service. Screw-shell-type lampholders should be made of porcelain.

Lenses may be made of glass or plastic. In the latter case, the material should be incombustible and a low-smoke-density type. It should be stable in color and strength. The increase in yellowness after 1000 hr of testing in an Atlas FDA-R Fade-Ometer in accordance with ASTM G23 should not exceed 3 IES-NEMA-SPI units. Acrylics are widely used.

Considerations in Fixture Selection. Because fixtures are designed for specific types of lamps and for specific voltage and wattage ratings of the lamps, a prime consideration in choosing a fixture is its compatibility with lamps to be used. Other factors to consider include:

Conformance with the chosen lighting method (see Art. 15.14)

Degree to which a fixture assists in meeting objectives for quantity and quality of light through emission and distribution of light

Luminous efficiency of a fixture, the ratio of lumens output by the fixture to lumens produced by the lamps

Esthetics—in particular, coordination of size and shape of fixtures with room dimensions so that fixtures are not overly conspicuous

Durability

Ease of installation and maintenance

Light distribution from fixtures, to summarize, may be accomplished by means of transmission, reflection, refraction, absorption, and diffusion. Reflectors play an important role. Their reflectance, consequently, should be high—at least 85%. The shape of a reflector—spherical, parabolic, elliptical, hyperbolic—should be selected to meet design objectives; for example, to spot or spread light in a building space or to spread light over a fixture lens that controls light distribution. (The need for a curved reflector, which affects the size of the fixture, can be avoided by use of a Fresnel lens, which performs the same function as a reflector. With this type of lens, therefore, a smaller fixture is possible.) Light control also is affected by shielding, baffles, and louvers that are positioned on fixtures to prevent light from being emitted in undesirable directions.

A wide range of light control can be achieved with lenses. Flat or contoured lenses may be used to diffuse, diffract, polarize, or color light, as required. Lenses composed of prisms, cones, or spherical shapes may serve as refractors, producing uniform dispersion of light or concentration in specific directions.

Types of Installations. Luminaires may be classified in accordance with type and location of mountings, as well as with type of lighting distribution: flush or recessed (Fig. 15.13), ceiling mounted (Fig. 15.14), pendant (Fig. 15.15), wall mounted (Fig. 15.16) or structural.

Structural lighting is the term applied to lighting fixtures built into the structure of the building or built to use structural elements, such as the spaces between joists, as parts of fixtures. Structural lighting offers the advantage of a lighting system conforming closely to the architecture or interior decoration of a room. Some types of structural lighting are widely used in residences and executive offices. For the purposes of accent or decorative lighting, for example, cornices, valences, coves, or brackets are built on walls to conceal fluorescent lamps. For task lighting, fixtures may be built into soffits or canopies. For general lighting, large, low-brightness, luminous panels may be set flush with or recessed in the ceiling.

Lighting objectives can be partly or completely met with portable fixtures in some types of building occupancies. For the purpose, a wide variety of table and floor lamps are commercially available. Because the light sources in such fixtures are usually mounted at a relatively low height above the floor, care should be taken to prevent glare, by appropriate placement of fixtures and by selection of suitable lamp shades.

Number and Arrangement of Luminaires. With the type of lamp and fixture and the required level of illumination known, the number of luminaires needed to produce that lighting may be calculated and an appropriate arrangement selected. The **lumen method of calculation**, which yields the average illumination in a space, is generally used for this purpose.

The method is based on the definition of footcandle (Art. 15.10.4), in accordance with which the level of illumination on a horizontal work plane is given by

$$fc = \frac{\text{lumens output}}{\text{area of work plane, ft}^2} \quad (15.35)$$

Lamp manufacturers provide data on initial lumen output of lamps, but these values cannot be substituted directly in Eq. (15.35), because of light losses in fixtures and building spaces and the effects of reflection.

To adjust for the effects of fixture efficiency, distribution of light by fixtures, room proportions and surface reflectances, and mounting height and spacing of fixtures, the design lamp output, lm , is multiplied by a factor CU , called **coefficient of utilization**, to obtain lumens output for Eq. (15.35). (CU is the ratio of lumens striking the horizontal work plane to the total lumens emitted by the lamps. It may be obtained from tables available from fixture manufacturers.) Thus,

$$fc = \frac{\text{design lamp output, } lm \times CU}{\text{area of work plane, } ft^2} \quad (15.36)$$

To adjust for decreasing illumination with time, initial lamp output, lm , is multiplied by a light loss factor LLF to obtain the design lamp output. (LLF is the ratio of the lowest level of illumination on the work plane just before corrective action is taken, such as relamping and cleaning, to the initial level of illumination, produced by lamps operating at rated initial lumens. Maintenance of lighting installations thus is taken into account in LLF) Substitution of this product in Eq. (15.36) yields

$$fc = \frac{\text{initial lamp output, } lm \times CU \times LLF}{\text{area of work plane, } ft^2} \quad (15.37)$$

Factors contributing to LLF include ballast performance, voltage to luminaires, luminaire reflectance and transmission changes, lamp outages, luminaire ambient temperature, provisions for removal of heat from fixtures, lamp lumen depreciation with use, and luminaire dirt depreciation.

The initial lamp output equals the product of the number of lamps by the rated initial lumens per lamp. Substitution in Eq. (15.37) and rearrangement of terms gives

$$\text{Number of lamps required} = \frac{fc \times \text{area}}{\text{initial } lm \text{ per lamp} \times CU \times LLF} \quad (15.38)$$

$$\text{Number of luminaires required} = \frac{\text{number of lamps required}}{\text{lamps per luminaire}} \quad (15.39)$$

Layout of luminaires depends on architectural and decorative considerations, size of space, size and shape of fixtures, mounting height, and the effect of layout on quality of lighting. Different types of fixtures may be used in a space; for example, one type to provide general lighting, other types to provide supplementary local lighting, and still other types to produce accent or decorative lighting.

Details of the lumen method of calculation are given in books on lighting (see Art. 15.20, Bibliography).

Manufacturers list the maximum permissible spacing for each type of luminaire in photometric reports on their products. This spacing depends on the mounting height, relative to the work plane, for direct, semidirect, and general-diffuse luminaires, and relative to the ceiling height for indirect and semidirect luminaires. Spacings closer than the maximum improve uniformity of lighting and reduce shadows. Perimeter areas, however, require much closer spacing, depending on location of tasks and on the reflectance of the walls; generally, the distance between luminaires and the wall should not exceed half the distance between luminaires, and in some cases, supplementary lighting may have to be added. Computer programs

are available for comparative analyses of different types and arrangements of luminaires.

15.18 SYSTEMS DESIGN OF LIGHTING

The objectives of and constraints on lighting systems and the interrelationship of lighting and other building systems are treated in this article. To design a lighting system for specific conditions, it is first necessary for the designer to determine the nature of and lighting requirements for the activities to be carried out in every space in the building. Also, the designer should cooperate with architects, interior designers, and structural, electrical, and HVAC engineers, as well as with the owner's representatives, to establish conditions for optimization of the overall building system. For example, where feasible, reflectances for ceiling, walls, and floor for each space may be selected for high lighting efficiency and visual comfort. Also, HVAC may be designed to remove and utilize heat from luminaires.

With tasks known, the designer should establish, for every space, criteria for illumination levels for task performance, safety, and visual comfort and also determine luminance ratios and light-loss factors. (For establishment of the light-loss factors, maintenance of the lighting system should be planned with the owner's representatives.) Based on the criteria and the lighting objectives, the designer can then decide how best to use daylighting and artificial lighting and select lamps and fixtures, luminaire mounting and layout, and lighting controls, such as switches and dimming. Because quality, color rendering, and quantity of light are interrelated, they should be properly balanced. This should be checked in an appraisal of the lighting system, which also should include comparisons of alternatives and studies of life-cycle costs and energy consumption. The analysis should compare alternatives not only for the lighting system but also for the other building components that affect or are affected by the lighting system.

Value analysis should examine illumination levels critically. A quantity of light that is sufficient for functional purposes is essential; but more light does not necessarily result in better lighting, higher productivity, or greater safety. Furthermore, higher illumination levels are undesirable, because they increase costs of lamps and fixtures, of lighting operation, of the electrical installation, and of HVAC installation and operation. Consequently, lighting should be provided, at the levels necessary, for visual tasks, with appropriate lower levels elsewhere, for example, for circulation areas, corridors, and storage spaces. Provision preferably should be made, however, for relocation or alteration of lighting equipment where changes in use of space can be expected.

The various types of lamps differ in characteristics important in design, such as color rendering, life, size, and efficacy. For each application, the most efficient type of lamp appropriate to it should be chosen. Consequently, prime consideration should be given to fluorescent and high-intensity-discharge lamps, which are highly efficient. Also, consideration should be given to high-wattage lamps of the type chosen, because the higher the wattage rating, the higher the lumen output per watt. Furthermore, in selection of a lamp, much more weight should be placed on life-cycle costs than on initial purchase price. Cost of power consumed by a lamp during its life may be 30 or more times the lamp cost. Consequently, use of a more efficient, though more expensive, lamp can save money because of the reduction in power consumption.

Similar consideration should also be given to luminaire selection. Efficient luminaires can produce more light on a task with less power consumption. Additional consideration, however, should be given to ease of cleaning and relamping, to prevention of direct glare and veiling reflections, and to removal of heat from the luminaires.

Control of lighting should be flexible. Conveniently located, separate switches or dimmers should be installed for areas with different types of activities. It should be easy to extinguish lights for areas that are not occupied and to maintain minimal emergency lighting, for safety.

Where feasible, daylighting should be used, supplemented, as needed, with artificial lighting. Light from windows can be reflected deeply into rooms, with venetian blinds, glass block, or other architectural elements. Glare and solar heat can be limited with blinds, shades, screens, or low-transmission glass. Provision should be made for decreasing or extinguishing supplementary artificial lighting when there is adequate daylight. Consideration should be given to use of photoelectric-cell sensors with dimmers for control of the artificial lighting.

Maximum use of daylighting and other energy conservation measures are often essential, not only to meet the owner's construction budget but also to satisfy the energy budget, or limitations on power consumption, set by building codes or state or federal agencies.

15.19 SPECIAL ELECTRICAL SYSTEMS

Enhancing the functions performed by the power and lighting systems, the special systems in a building serve the life safety, communication, and security needs of a facility and its occupants.

15.19.1 Lightning Protection

The design of lightning protection systems should conform with the standards of the American National Standards Institute, the National Fire Protection Association (Bulletin No. 780, "Lightning Protection Code") and Underwriters Laboratories (Standard UL96A "Master-Labeled Lightning Protection Systems").

In deciding whether to provide a building lightning protection system, designers should first perform a risk assessment in accordance with NFPA 780, "Lightning Protection Code." This evaluates such factors as building height, terrain, building construction, proximity to other buildings, type of occupancy, and isoceraunic level (frequency of thunderstorms). If the risk assessment warrants, a lightning protection system is designed.

Protection for a building may be accomplished by several methods. An installation recognized by NFPA and UL consists of lightning rods or air terminals placed around the perimeter of the roof and on vertical projections, such as chimneys and the ridge of a peaked roof. These air terminals are bonded together and to a copper or aluminum conductor that extends down to a good electrical ground. There are also two less conventional types of installation that can be used. One involves the use of an air terminal containing a low-level radioactive source that produces a stream of ionized particles. This creates a low-resistance path that draws a lightning stroke to the air terminal, where it can be safely discharged to ground. The other

type uses thousands of small air terminals spread along the high points of a structure to constantly dissipate any electrical charge in the air before it can build up high enough to induce a lightning stroke.

The electrical wiring in a building is especially susceptible to the effects of a lightning stroke. To minimize these effects, a multilevel protective approach is used. Lightning arresters, which are connected from the phase wires to ground, are provided on the utility company lines and at the various voltage levels down to utilization voltage. Usually of the metallic oxide varistor (MOV) type, the arresters present a very high resistance to ground at normal system voltage, but quickly collapse to zero resistance during a lightning discharge, dissipating the discharge to ground.

At sensitive electronic loads, it is necessary to provide a higher level of protection against the effects of lightning and other voltage disturbances by providing transient-voltage surge suppressors (TVSS). These devices utilize silicon-controlled rectifiers (SCR) or combinations of SCRs and MOVs that closely limit the peak surge voltage and react within 5 nanoseconds to voltage surges.

15.19.2 Fire-Alarm Systems

These provide means of detecting a fire, initiating an alarm condition, either manually or via automatic detection, and responding to that alarm condition. A fire-alarm system consists of a central fire-alarm control panel; perhaps several remote subpanels; initiating devices, such as manual pull stations, smoke detectors, sprinkler-flow switches; and alarm devices, such as horns, gongs, and flashing lights. The control panel provides power to the system components and monitors the status of all of the initiating devices. It also monitors all fire-protection-system functions and supervises the condition of the wiring. In addition, the control panel provides outputs, under alarm conditions, to shut down air-conditioning fans, initiate smoke evacuation, close smoke doors, initiate elevator capture, release fire suppressants, activate alarm devices, and notify the fire department.

Larger systems are generally of the addressable type. The control panels are microprocessor based. Each device has a digital electronic identifier, or address. A control panel sequentially polls each device to check its status. This method allows as many as 30 devices to be connected to a single circuit and can greatly reduce the wiring costs of the fire-alarm system.

Design of the fire-alarm system must comply with the requirements of the National Fire Protection Association and local governing authorities. It is essential that fire-alarm systems be designed to interface with the HVAC system controls for unit smoke detection and shutdown and for smoke-exhaust-system control. Fire-alarm systems also should interface with the fire-protection system to monitor building sprinkler-system components and other fire-suppression systems. System design should also consider the building type and occupancy in selecting components and materials. Particular care should be taken in design of fire-alarm systems for high-rise buildings (over 75 ft high), which will require a firefighter's control panel, fire phone system, and voice-evacuation system as a minimum.

15.19.3 Communications Systems

These may include telephone, paging, and intercom systems. Telephone systems in large buildings generally have telephone service to a computerized business

exchange (CBX), or switch, that controls the telephone system functions. It can offer numerous desirable features such as direct inward dialing, voice mail, speed dialing, system forward, conference, forward, message waiting, queuing, and transfer. The switch is located in a telephone service closet and requires power (preferably conditioned power) and air conditioning.

Telephone service is distributed via cables in conduit extending from telephone service room to telephone closets on each floor. Each closet should have a plywood backboard, for mounting equipment and punch-down boards, and two duplex receptacles. For distribution of telephone cables to their point of use, ladder-type cable trays can be routed above corridor ceilings from the telephone closets throughout each floor. Telephone cables must be suitable for running in cable trays and must be rated for use in air-handling spaces.

Telephone outlets consist of a single-gang outlet box with stainless steel cover plate, modular phone jack, and $\frac{3}{4}$ in electrical metallic tubing, which is run concealed to the cable tray. Telephones may be digital electronic type with programmable function buttons in addition to the 12-button tone pad, plus speaker phone and intercom features.

15.19.4 Intercom and Paging Systems

Intercom can be an integral function of the telephone system or a separate system.

Many buildings have a paging system of some sort. This can be a telephone system function, but it is most often a separate system consisting of receivers, playback equipment, amplifiers, speakers, telephone interface, and a microphone. The system may offer selective paging of certain areas, all-call paging of the entire facility, and background music.

15.19.5 Security Systems

These can range in sophistication from a combination lock (pad of numbered push buttons) or a simple card reader at the entry door to a comprehensive system integrating physical barriers, electronic access controls, surveillance, and intrusion detection systems (IDS). Although a card reader usually suffices for access control, high-value and high-security facilities often require biometric identification systems, such as retinal scan or hand geometry, for control of access.

Intrusion detection systems usually are of either of two types. One is a perimeter system, such as door switches, break-glass detectors, optical, or microwave beams, which creates an electronic envelope around a space. The other is a volumetric system, passive infrared or ultrasonic, which detects an intruder's presence in the protected space.

Closed-circuit television (CCTV) cameras may be provided to allow security persons to continuously watch for intruders at any of many locations from one point. Since several cameras may be required, video sequencers are provided that display the images from each of the cameras in turn on one or more monitors. Sequencers may be connected to the IDS to display and hold the image from a camera located where an alarm occurs.

A central security computer controls all of the security system functions. It monitors all of the devices and wiring, presents trouble and alarm messages to security staff, and keeps a historical record of all events such as authorized entries and alarms.

15.19.6 Television Distribution Systems

These are provided for apartment buildings, schools, and correctional facilities. There are two basic types, MATV (master antenna television), and CATV (community antenna television, usually referred to as cable TV). There are two principal differences between the systems. One is the source of signal; MATV systems require an antenna or a satellite dish to receive broadcast signals, whereas CATV systems receive signals from a cable system via a coaxial cable. The other difference is economic; MATV systems have a higher first cost to the builder but require only maintenance costs thereafter; CATV systems have lower first cost (the cable system may provide the wiring and equipment at no cost if the potential revenues are high enough) but require payment of a monthly fee by the users.

15.19.7 Data Network Systems

These are provided to allow free interchange of data between small groups of computers in a local area network (LAN) and between several LANs connected to a backbone network. Data transmission media may be wire, twisted-pair or coaxial cable, or fiber-optic cable. System topologies may be ring networks or radial (star) networks. Regardless of the type of network chosen, careful integration of the cabling system and hardware requirements into the building design is necessary.

Cabling closets are required for location of interface equipment and connector panels. A raceway system is required to distribute cables to the computer equipment. Often, the cabling conveyance used for the telephone system can be shared by the data network systems. For a more detailed treatment, see Communications Systems, Section 18.

15.19.8 Intelligent Buildings

Design of an intelligent building integrates many or all of the systems listed above, plus HVAC systems, building operations, and even the building itself into a coordinated productivity tool for the occupants. The objective is to maximize efficiency today and adaptability for functional and technological changes tomorrow.

15.19.9 Special System Wiring

Circuits for the special systems previously discussed should meet the functional needs of the systems as well as the requirements of the National Electrical Code. The code divides these types of circuits into three classes and provides separate requirements for each.

Class 1 circuits are similar to power circuits in that they are permitted to carry up to 600 V and, in general, are subject to the same installation requirements. One exception is that use of No. 18 wire is permitted for Class 1 circuits. Special insulation and overcurrent protection devices are also permitted. Thermostats and other sensing devices controlling remote motor starts, available at 120 V, may be incorporated in Class 1 circuits and may use No.18 wire, but with overcurrent protection not exceeding 20 A.

Class 2 and 3 circuits are limited to a maximum of 150 V. The conductors may not be placed in the same raceway as power circuits. Class 2 wire should provide

protection against both fire and electric shock, whereas Class 3 wire should offer protection primarily against fire.

15.19.10 Power Distribution Management System

A power distribution management system (PDMS) is an integrated system of hardware and software that allows building operating personnel to monitor and control the building power-distribution system from a single location. PDMS systems are available from several manufacturers, either integral to a new electrical system or as an add-on in an existing building. Electronic interface devices, located in substations, switchgear, motor control centers, etc., provide real-time monitoring of system quantities like voltage, current, power factor, and frequency. They also enable remote control of circuit breakers, transfer switches, and starters. One or more remote terminal units (RTU) are provided in the field to tie-in the interface devices to the central processing unit (CPU) via a data highway. The data highway may use twisted-pair wiring, fiberoptic cable, or another transmission medium. It is also possible to interface the PDMS to other building systems, such as process-control or building automation systems.

The CPU is generally a personal computer (PC) which contains the PDMS software and, through its keyboard and screen, acts as the operator interface to the system. A single-line diagram representing the power distribution system is programmed into the CPU and is used by the operator to access system information, identify system faults, or remotely operate electrical equipment. The software allows continuous monitoring and archival storage of all electrical data. It also offers reporting functions that can be used to maximize operating efficiency and forecast impending faults. Should a fault occur, an alarm appears on the screen showing its location on the single-line diagram and all pertinent data. This information can be used to effect repairs and restore service quickly. Hand-held remote programmers can be connected to RTU's to adjust system settings in the field or to help repair efforts.

15.20 ELECTRICAL SYSTEMS BIBLIOGRAPHY

From Illuminating Engineering Society of North America, 345 East 47th St., New York, NY 10017:

“Lighting Handbook”

“Recommended Lighting Practices,” RP-1 et al.

“Energy Management Series,” EMS-1 et al.

From National Fire Protection Association, 1 Batterymarch Park, Quincy, MA 02269:

“National Electrical Code”

“National Electrical Code Handbook”

From John Wiley & Sons, Inc., New York:

B. Stein, et al., “Mechanical and Electrical Equipment for Buildings”

From McGraw-Hill, Inc., New York:

T. Croft and W. Summers, “American Electrician’s Handbook”

M. D. Egan, “Concepts for Lighting in Architecture”

D. G. Fink and H. W. Beaty, “Standard Handbook for Electrical Engineers”

- A. E. Fitzgerald and C. Kingsley, Jr., "Electric Machinery"
- T. Gonen, "Electric Power Distribution System Engineering"
- A. Kusko, "Emergency Standby Power Systems"
- E. C. Lister, "Electrical Circuits and Machines"
- J. F. McPartland and B. J. McPartland, "McGraw-Hill's National Electrical Code Handbook"
- L. Watson, "Lighting Design Handbook"